

# Accelerator R&D in support of Energy, Intensity and Cosmic Frontiers : *A few selected examples*

*Swapan Chattopadhyay*  
*NIU / Fermilab / CERN*

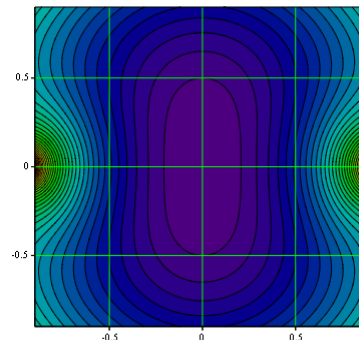

**Laboratoire de l'Accelérateur Lineaire  
in2p3 Seminar  
University of Paris Sud  
July 28, 2015**



# OUTLINE

- **Prelude**
- **Accelerator R&D for the Energy Frontier**
  - FCC @CERN (hh, e+e-) design effort*
  - AWAKE – proton beam driven plasma wake-field experiment*
- **Accelerator R&D at the Intensity Frontier:**
  - PIP-II at Fermilab*
  - IOTA- test facility : A “smart” booster synchrotron or an “ i - Booster” with a fundamentally “nonlinear” external electromagnetic optics designed for clever cancellation of beam “Coulomb” space-charge nonlinearities and associated resonances at the designed intensity*

---
- **Accelerator R&D at the Precision Frontier (Time permitting)**
  - “Mu-2-e” Experiment*
  - “g-2” Experiment*

---
- **Cavity Electrodynamics for “Dark Matter” Search**
- **Outlook**

# Acknowledgments

*Sergei Nagaitsev (FNAL)*

*Vladimir Shiltsev (FNAL)*

*Alexander Valishev (FNAL)*

*Eric Prebys (FNAL)*

*Nigel Lockyer (FNAL)*

*Michael Eads (NIU)*

*Fabiola Gianotti (CERN)*

*Michael Benedikt (CERN)*

*Frank Zimmermann (CERN)*

*Daniel Schulte (CERN)*

*Yi-Feng Wang (BEPC, PRC)*

*Nathan Woollett (Cockcroft Institute)*

*Allen Caldwell (MPI Munich)*



*“Nothing tends so much to the advancement of knowledge as the application of a new instrument”*

-- Sir Humphrey Davy in “Elements of Chemical Philosophy” (1812)

**Accelerators are grand instruments of science using charged /neutral particles and light, from laboratory scale to grand dimensions, enabling “precision” and “discovery-class” research.**

**TODAY'S HIGHEST ENERGY PARTICLE COLLIDER:**  
**Large Hadron Collider at CERN, Geneva**  
**→ Enabled Major Discovery of the**  
**Early 21<sup>st</sup> century**

**HIGGS!**

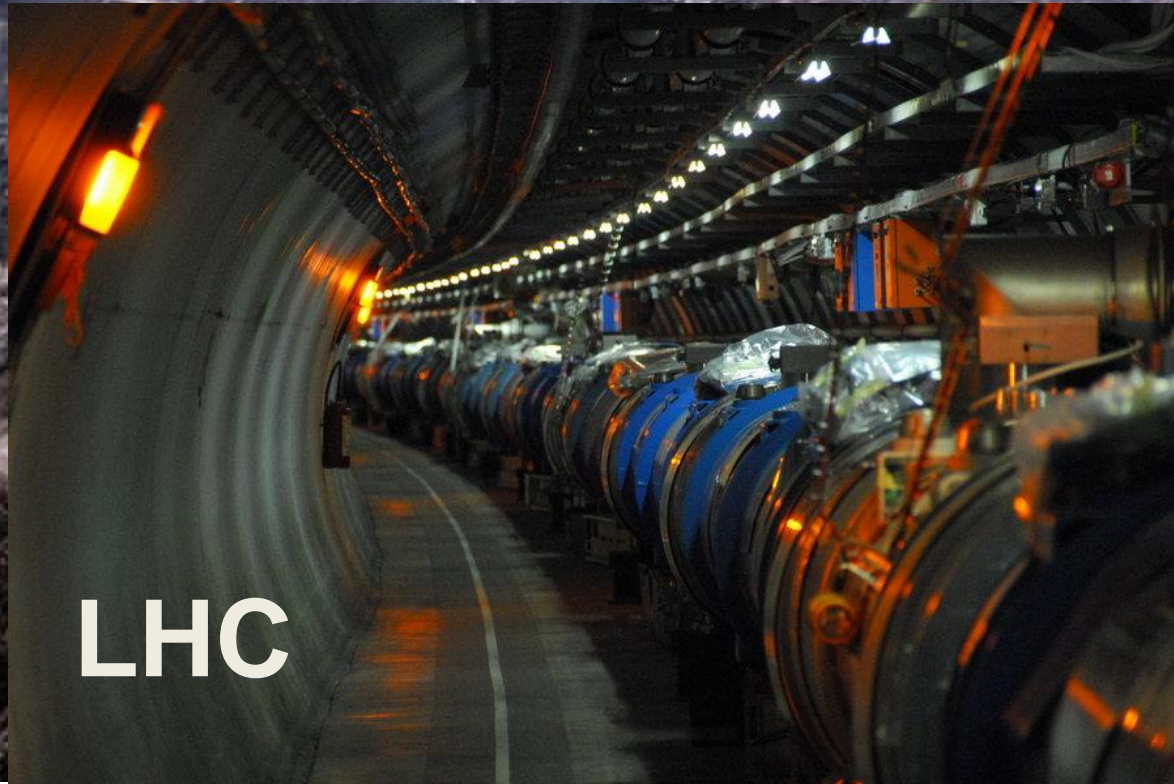

**LHC**

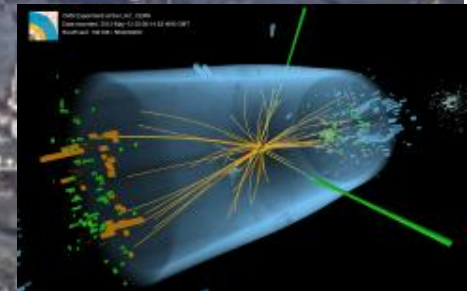

**→ NEXT?**

# SCALES of FUTURE POSSIBILITIES IN PARTICLE PHYSICS: *Time, Effort, Cost*

## LHC HIGGS?

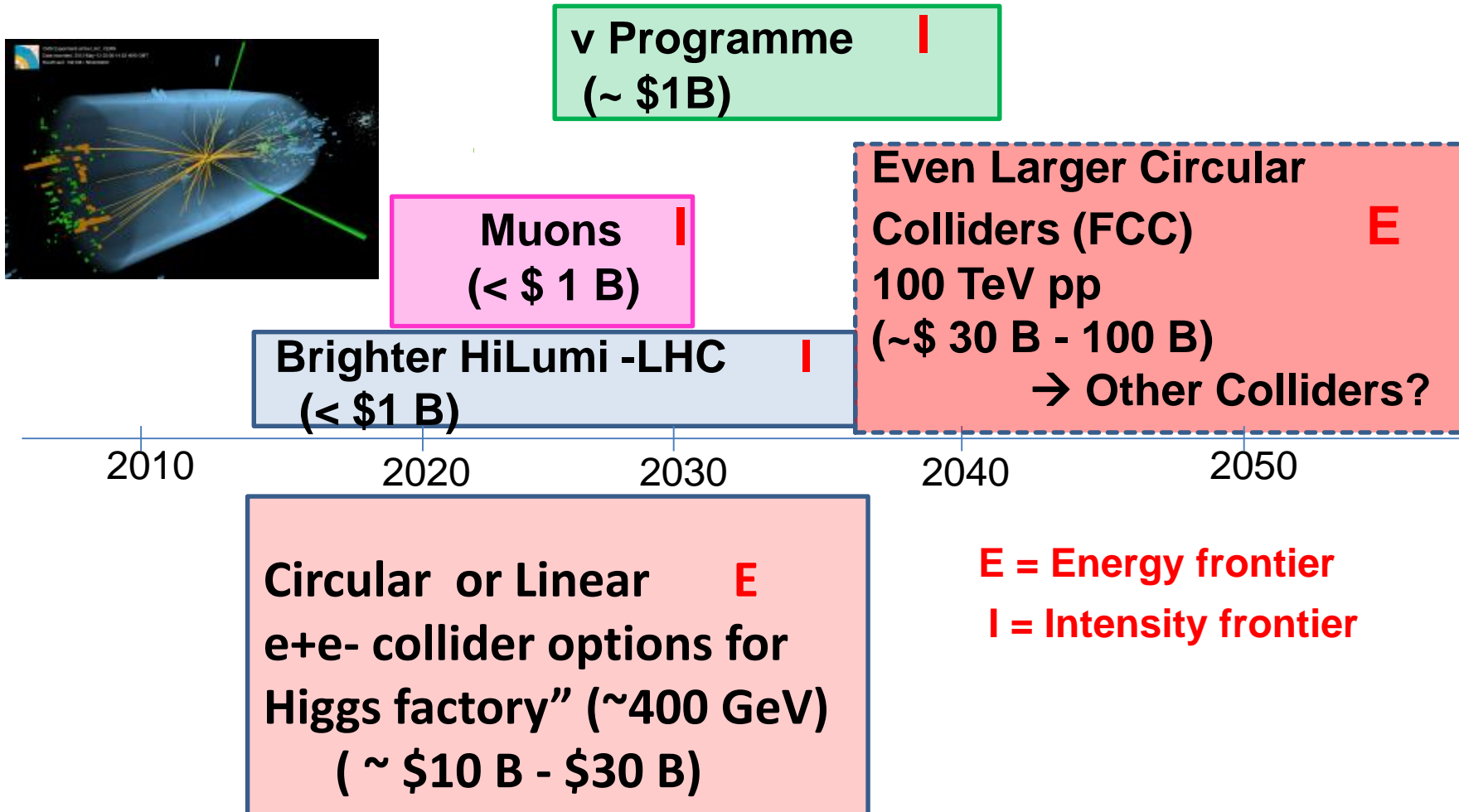

# Main questions in particle physics and main

question	high-energy colliders	high-precision experiments	neutrino experiments	dedicated searches	cosmic frontier
Higgs, EWSB	X				
Neutrinos	X		X	X	X
Invisible “Dark” Matter	X			X	
Flavour, CP-violation: “Matter-antimatter”	X	X	X	X	
New Particles and Forces	X	X	X	X	
Universe Acceleration: Hidden “Dark” Energy		F. Gianotti et al.			X
<b><i>Most of these questions require high-energy and/or high-intensity accelerators.</i></b>					

# Energy Frontier



# Recent Community-driven Strategies

- **European Strategy for Particle Physics 2013:**

“... exploit current LHC to its fullest at the highest energy and luminosity possible, then to propose an ambitious post-LHC accelerator project....., CERN should undertake design studies for accelerator projects in a global context,...with emphasis on proton-proton and electron-positron high-energy frontier machines.....”

- **US P5 recommendation 2014:**

“....A very high-energy proton-proton collider is the most powerful tool for direct discovery of new particles and interactions under any scenario of physics results that can be acquired in the P5 time window....”

# CERN



# CERN Future Circular Colliders (FCC) design study

*Aiming for CDR and Cost Review for the next European Strategy Mtg. (2018)*

- 80-100 km tunnel infrastructure in Geneva area
- design driven by pp-collider requirements with possibility of e<sup>+</sup>-e<sup>-</sup> (TLEP) and p-e (VLHeC)
- CERN-hosted study performed in international collaboration

15 T ⇒ 100 TeV in 100 km  
20 T ⇒ 100 TeV in 80 km

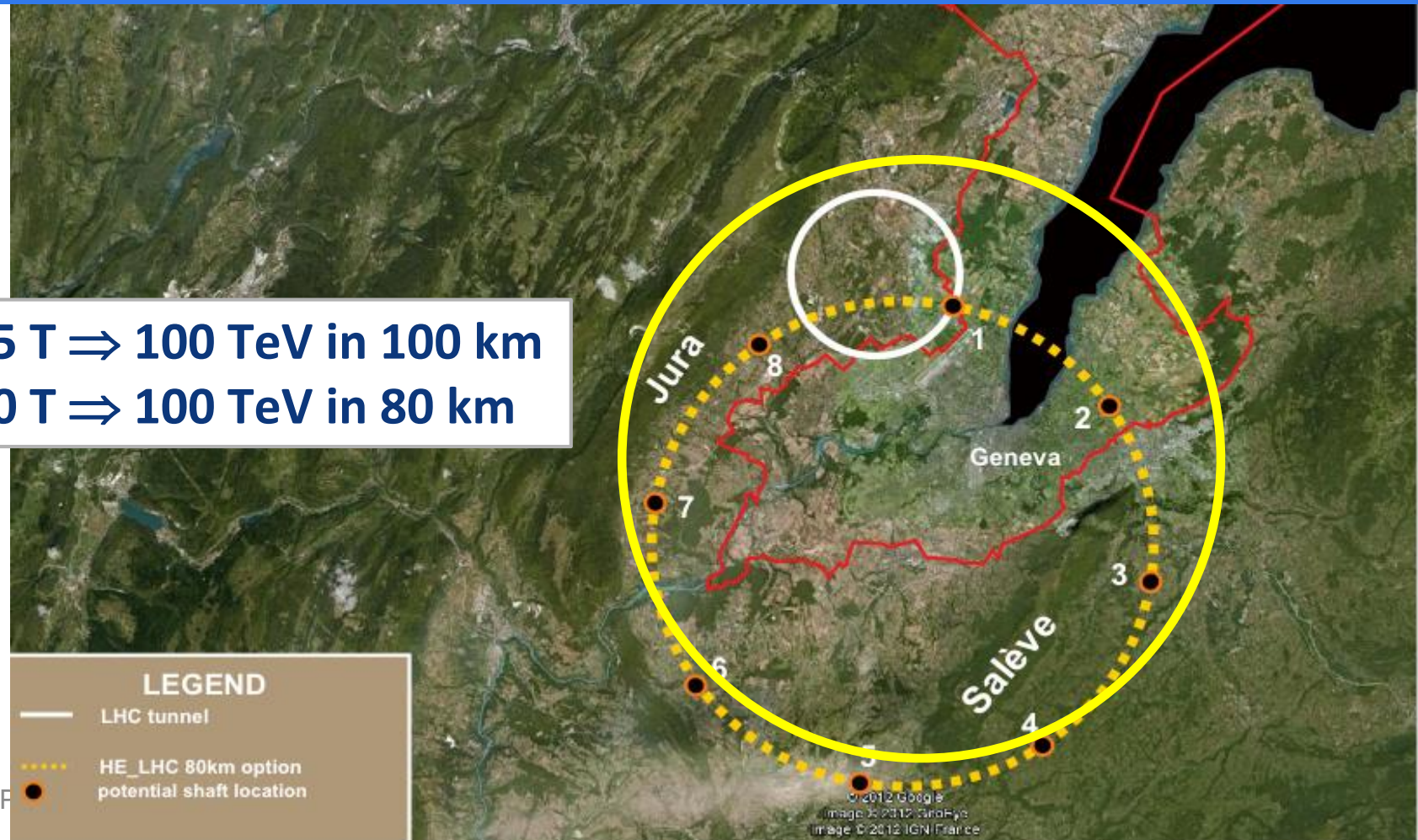

# Peoples Republic of China : CEPC, SPPC – Site Investigation

300 km from Beijing

A good example is 秦皇岛:

3 hours by car; 1 hours by high speed train

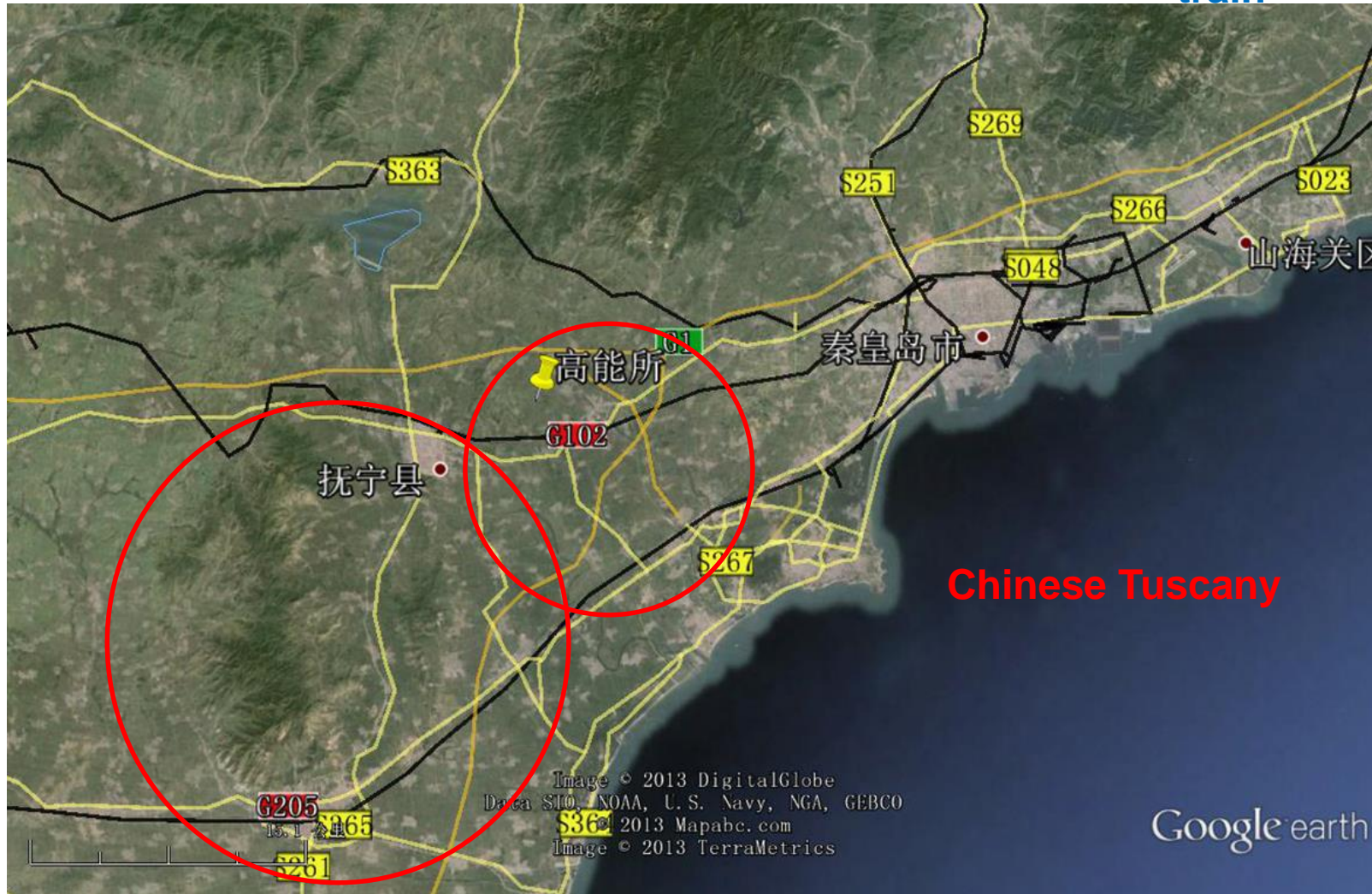

# CERN Circular Colliders + FCC

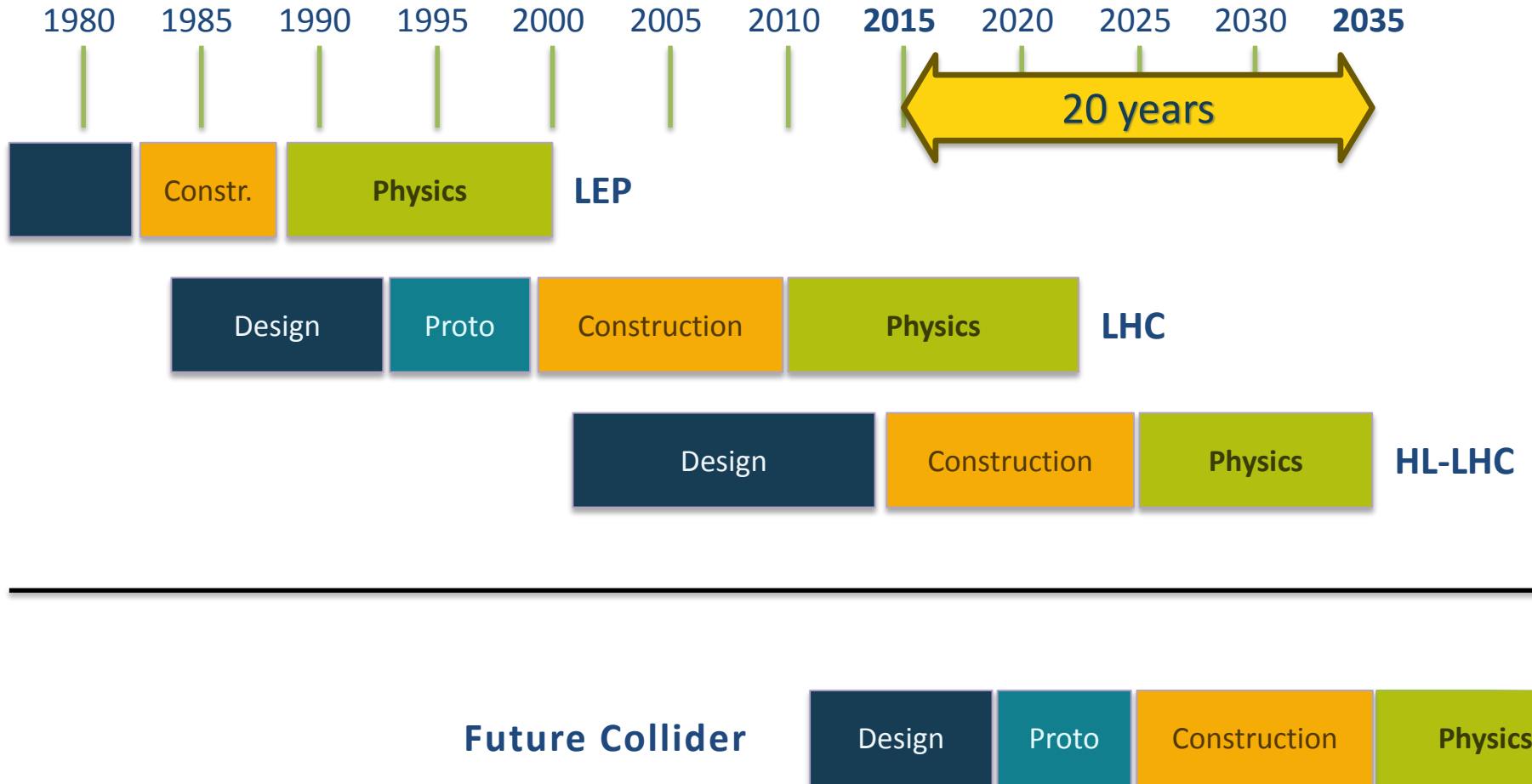

# Key Parameters FCC-hh-CERN

Parameter	FCC-hh	LHC
Energy [TeV]	100 c.m.	14 c.m.
Dipole field [T]	16	8.33
# IP	2 main, +2	4
Luminosity/IP <sub>main</sub> [cm <sup>-2</sup> s <sup>-1</sup> ]	5 - 25 x 10 <sup>34</sup>	1 x 10 <sup>34</sup>
Stored energy/beam [GJ]	8.4	0.39
Synchrotron rad. [W/m/aperture]	28.4	0.17
Bunch spacing [ns]	25 (5)	25

# Key Parameters FCC-ee-CERN

Parameter	FCC-ee			LEP2
Energy/beam [GeV]	45	120	175	105
Bunches/beam	13000-60000	500-1400	51- 98	4
Beam current [mA]	1450	30	6.6	3
Luminosity/IP $\times 10^{34} \text{ cm}^{-2}\text{s}^{-1}$	<b>21 - 280</b>	<b>5 - 11</b>	<b>1.5 - 2.6</b>	0.0012
Energy loss/turn [GeV]	0.03	1.67	7.55	3.34
Synchrotron Power [MW]	100			22
RF Voltage [GV]	0.3-2.5	3.6-5.5	11	3.5

Dependency: crab-waist vs. baseline optics and 2 vs. 4 IPs

## Key technology issues

- High Field superconducting magnets (16 T)
- Synchrotron radiation and beam-screen vacuum chamber
- Efficient RF
- Tunnel



# Key Technology R&D - HFM

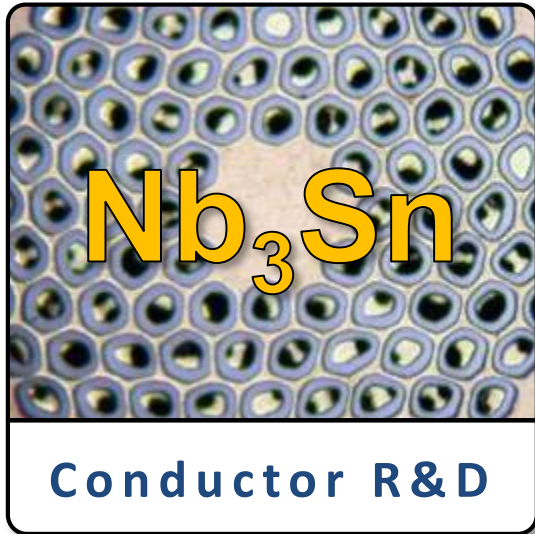

- Increase critical current density
- Obtain high quantities at required quality
- Material Processing
- Reduce cost



- Develop 16T short models
- Field quality and aperture
- Optimum coil geometry
- Manufacturing aspects
- Cost optimisation

# Promise of High-Field SC Magnets

*FCC-hh Challenges: Magnets: Integration of Mechanics and Electromagnetism: Lorentz Forces and Stored Energy:  
**This is where Newton confronts Maxwell!!!!***

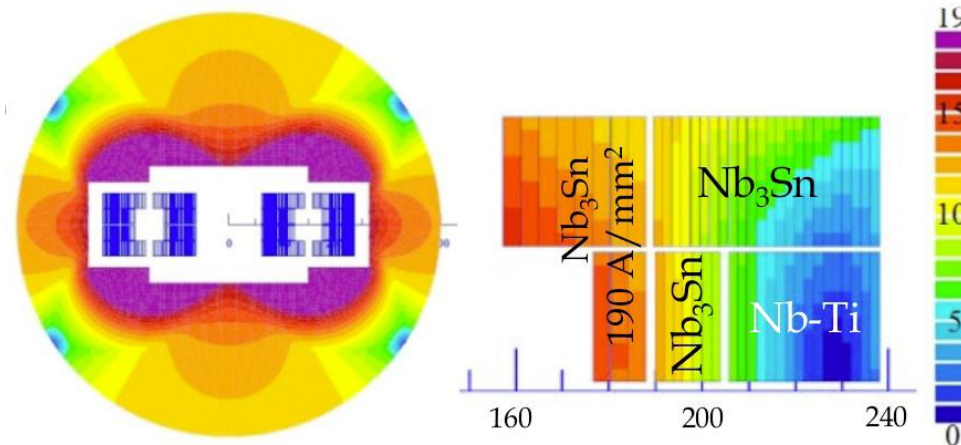

**Arc dipoles are the main cost and parameter driver**

**Baseline is Nb<sub>3</sub>Sn at 16T**

**HTS at 20T also will be studied as alternative**

**Field level is a challenge but many additional questions:**

- Length, weight and cost, Aperture, Field quality, Separation**

*Major technology issue: Synchrotron Radiation and Beam Screen → High Frequency Behavior of High Temperature Superconducting Layer inside Beampipe: a novel research topic*

- Synchrotron radiation power**
- ~30W/m/beam in arcs ( $E_{\text{crit}}=4.3\text{keV}$ ), total 5 MW (LHC 7kW)**
- ⇒ **Cooling challenge**
- ⇒ **Vacuum challenge**
- ⇒ **Impedance challenge**
- ⇒ **Mechanical challenge**
- ⇒ **Electron cloud**
- ⇒ **Cost challenge**

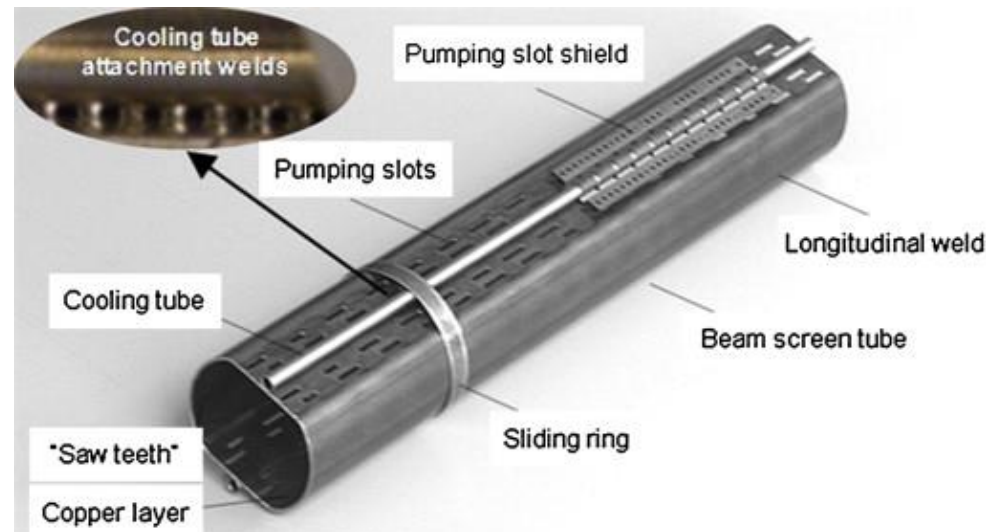

**LHC beamscreen**

**Choice of beam-screen temperature is 50K and 5MW synchrotron radiation => 100MW of cooling power. Good vacuum between 40-60K. Impedance still reasonable.**

**Both FCC and LHC and HL-LHC will require transversely deflecting Radio-frequency “Crab” cavities**

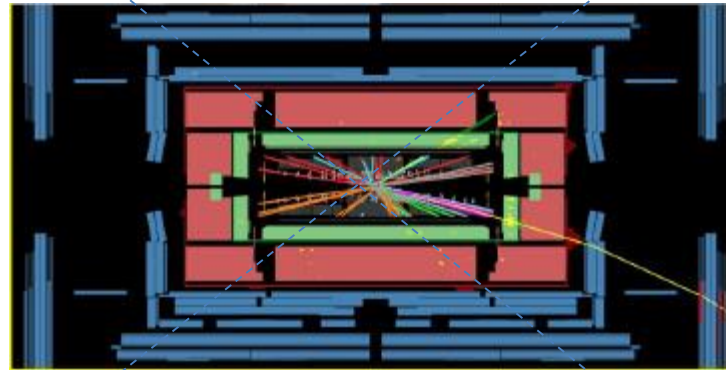
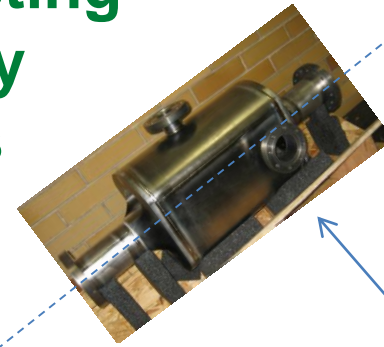
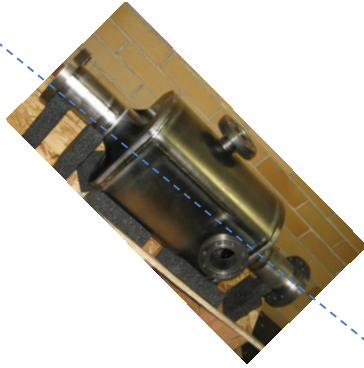

**IR**

**Manipulating Microwave Cavities**

**Challenging to accelerate and control very “stiff” high energy beams to 100 nm – 1 micron precision!!!**

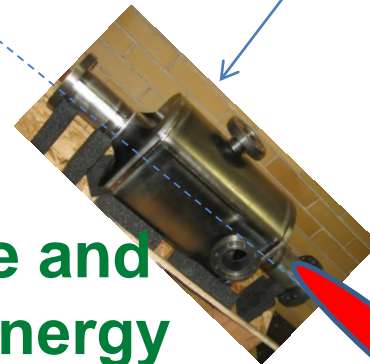
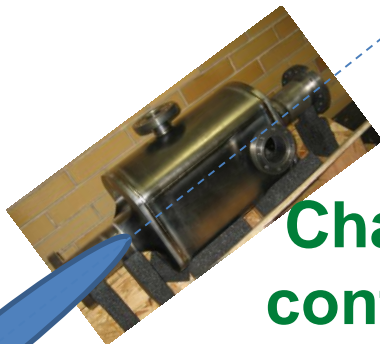

# FCC-ee Top-up Injection → major beam dynamics issue

luminosity scaling: larger  $E$  &  $\rho$

$efkN = \text{beam current} \propto \frac{1}{E^4}$

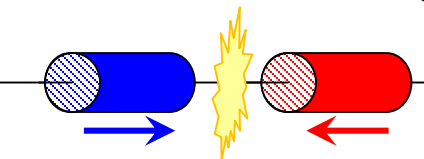

$$L = \frac{fkN^2}{4\pi\sigma_x\sigma_y} FH$$

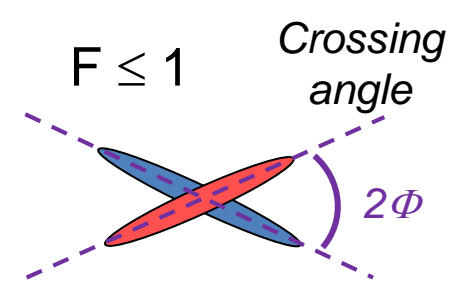
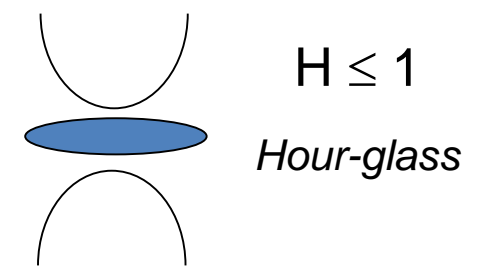

$\xi_y \propto \frac{\beta_y^* N}{E\sigma_x\sigma_y} \leq \xi_y^{\max}(E)$  Beam-beam parameter

$$L \propto \frac{\rho P_{SR}}{E^3} \frac{\xi_y}{\beta_y^*}$$

**FCC-ee  
RF & Sync. Rad  
main technology  
issues**

- $\sigma$  = beam size
- $k$  = no. bunches
- $f$  = rev. frequency
- $N$  = bunch population
- $P_{SR}$  = synch. rad. power
- $\beta^*$  = betatron fct at IP (beam envelope)

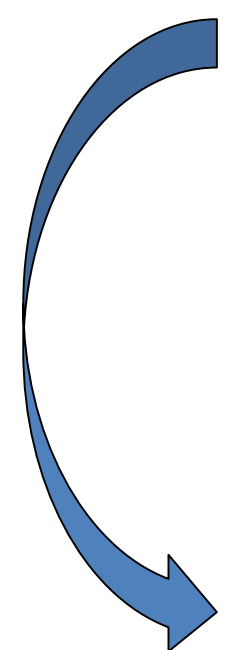

# Key Technology R&D for FCC-ee- RF

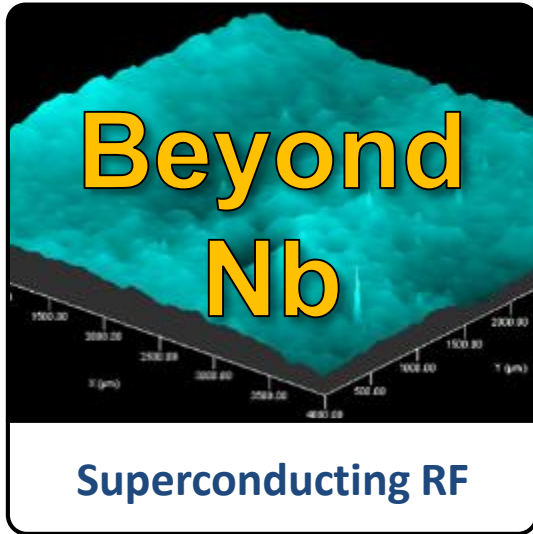

- Cavity R&D for large  $Q_0$ , high gradient, acceptable cryo power
- Multilayer additive manufacturing combining Cu and LTS materials
- High quality over large surfaces



- Push Klystrons far beyond 70% efficiency
- Increase power range of solid-state amplifiers
- High reliability for high multiplicity

# Collaboration Status

- 51 institutes
- 19 countries
- EC participation



# AWAKE:



## *A proton beam driven plasma wakefield acceleration experiment*

## Motivation

- (Large) accelerators have been central to advances in particle physics;
- Do we have new technologies to reduce costs and size?
- Accelerating gradients in plasma wakefield acceleration are high;
- Ultimate goal of a multi-TeV lepton collider of few km in length as an energy-frontier electron-positron collider;
- The next energy-frontier machines being studied today are either in the FCC context (large circular pp or ee) or large linear colliders.

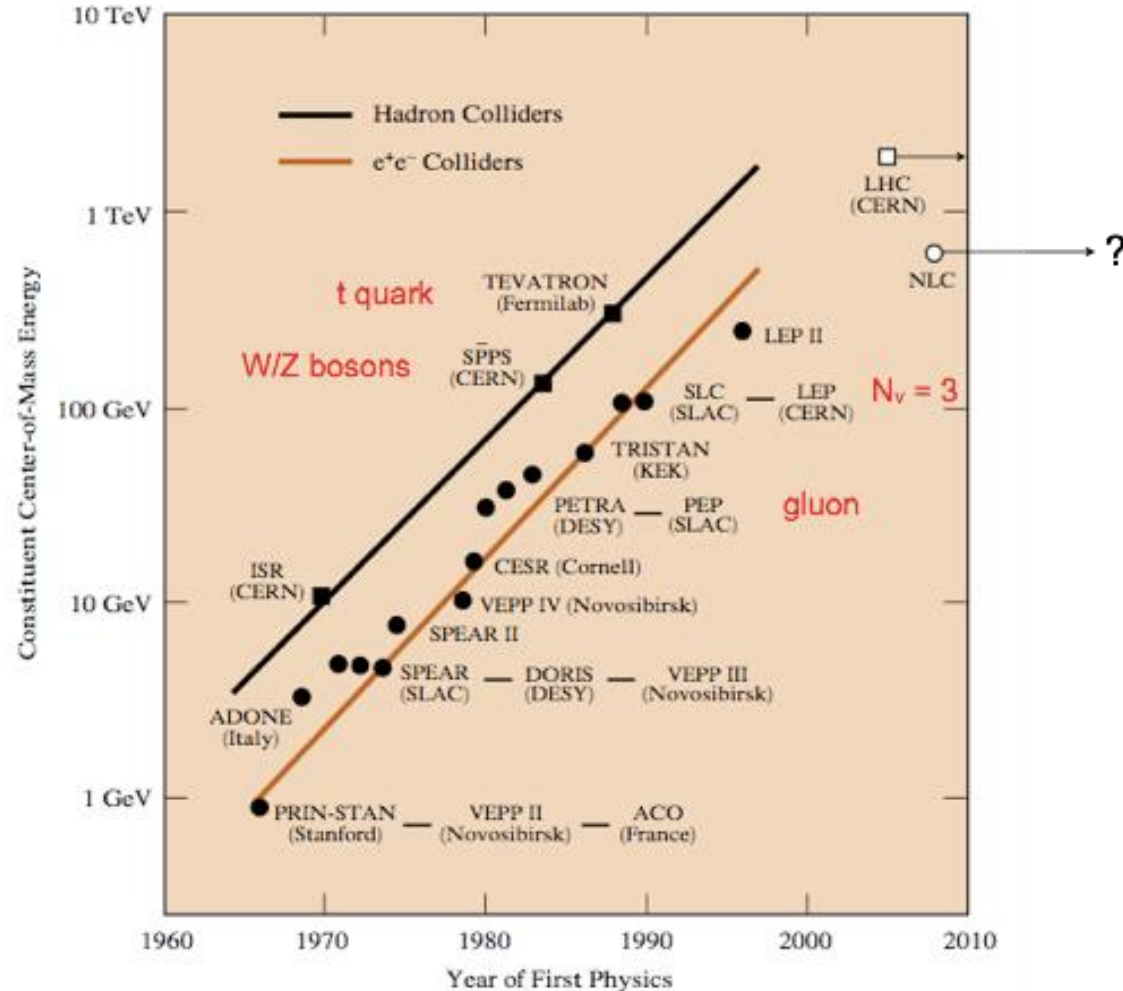



# Motivation



- Laser-plasma wakefield acceleration has made great advances producing GeV class electron beams in compact setting;
- Electron beam-driven plasma wakefield acceleration has also shown high gradients and energy-doubling of 42 GeV to 85 GeV in a single pass;
- **However, both have limitations: laser-plasma approach being limited by the multiple staging needed for reaching high energies relevant for particle physics, while electron beam-plasma approach being limited by the energy of the drive beam and maximum possible “transformer ratio”;**
- Research spread over all possible other applications e.g. radiation sources, medical applications etc.
- Proton beams such as in the 7TeV LHC carry significant stored energy (>140 kilojoules per pulse) that can be transformed into a TeV class electron beam using a plasma channel as the wakefield transformer. Hence using a proton driver is the best option for particle physics ;
- This is a focused programme based at CERN in order to investigate a technology which could lead to future energy-frontier machines.

# Motivation: PDPWA Concept

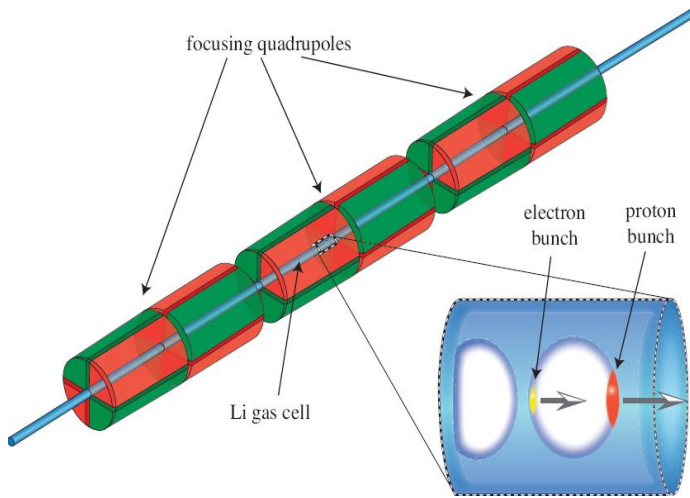

- Plasma can sustain very large electric field (GV/m-TV/m), and the plasma wakefield can be harvested for beam acceleration;
- Proton-driven plasma wakefield acceleration (PD-PWFA) can accelerate electron bunch to the energy frontier (TeV) in a single stage, while the transverse electric fields focus the accelerating bunch;
- This requires ultra-short proton beams not yet achievable in practice. Compromise can be reached by using plasma-modulated proton beams as a driver;
- An international collaboration (AWAKE) has been set up for experimental study of proton-driven PWFA using SPS beam.

$E_e = 0.6 \text{ TeV}$  from  $E_p = 1 \text{ TeV}$  in 500 m

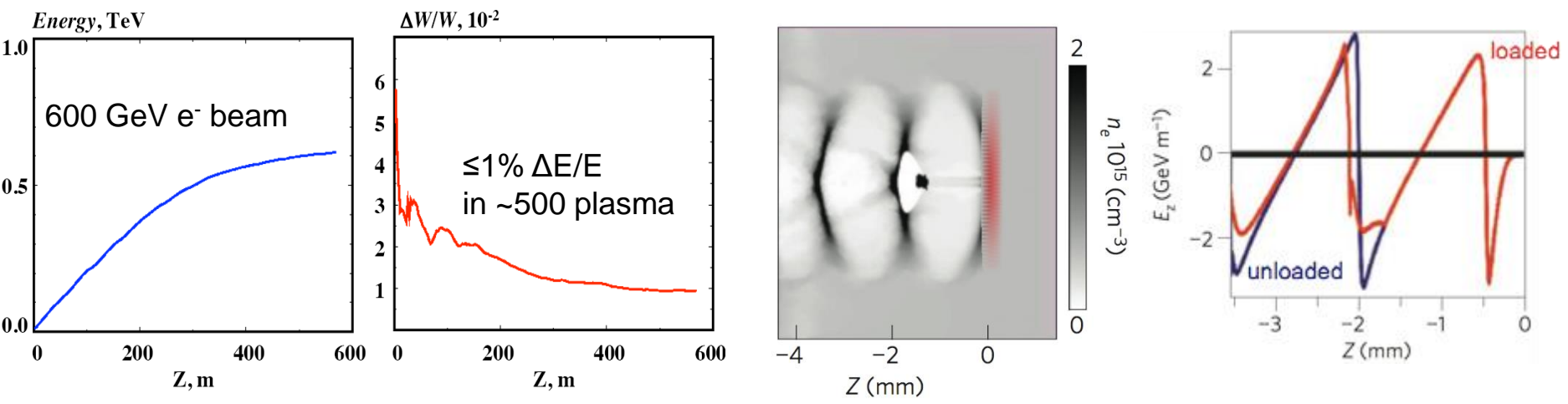

A. Caldwell et al, Nature Physics 5, 363 (2009).

# Proton-beam modulation

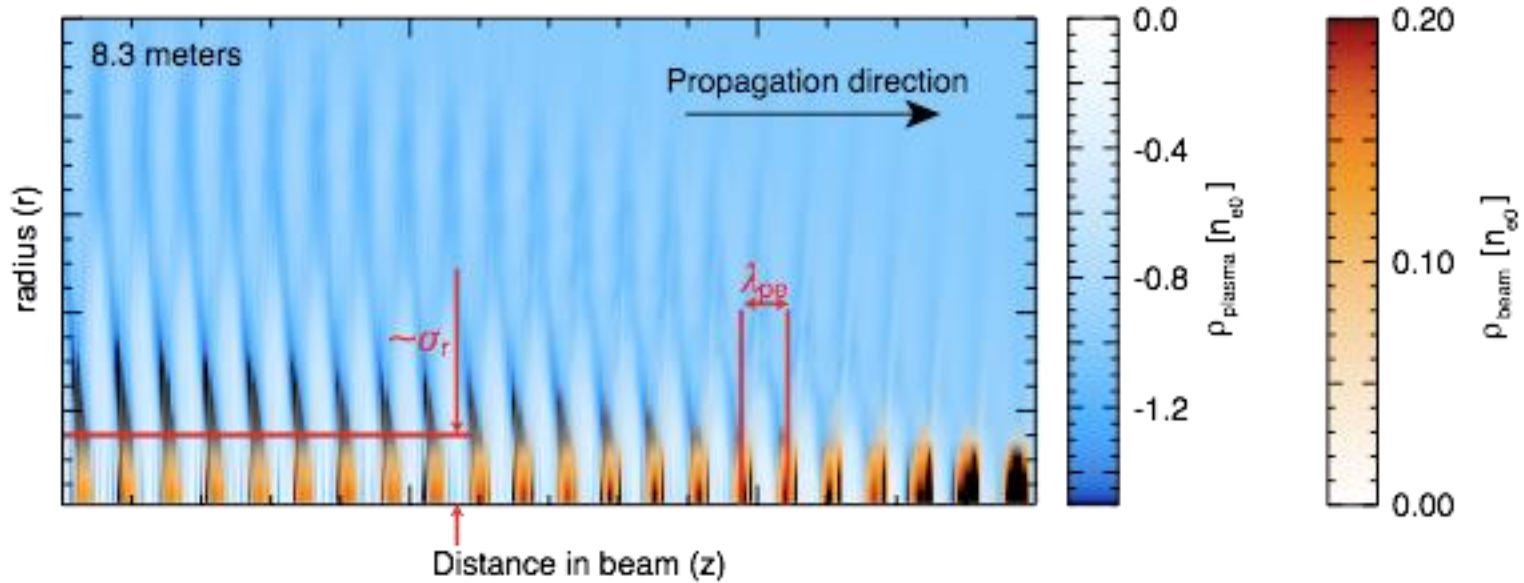

## CERN SPS proton beam

Proton bunch population,  $N_b$

Proton bunch length,  $\sigma_z$

Proton bunch radius,  $\sigma_r$

Proton energy,  $W_b$

Proton bunch relative energy spread,  $\delta W_b / W_b$

Proton bunch normalized emittance,  $\epsilon_{bn}$

$3 \times 10^{11}$

12 cm

0.02 cm

400 GeV

0.35%

3.5 mm mrad

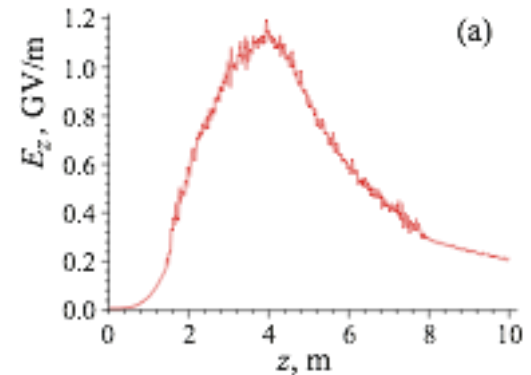

# Injection of witness electrons

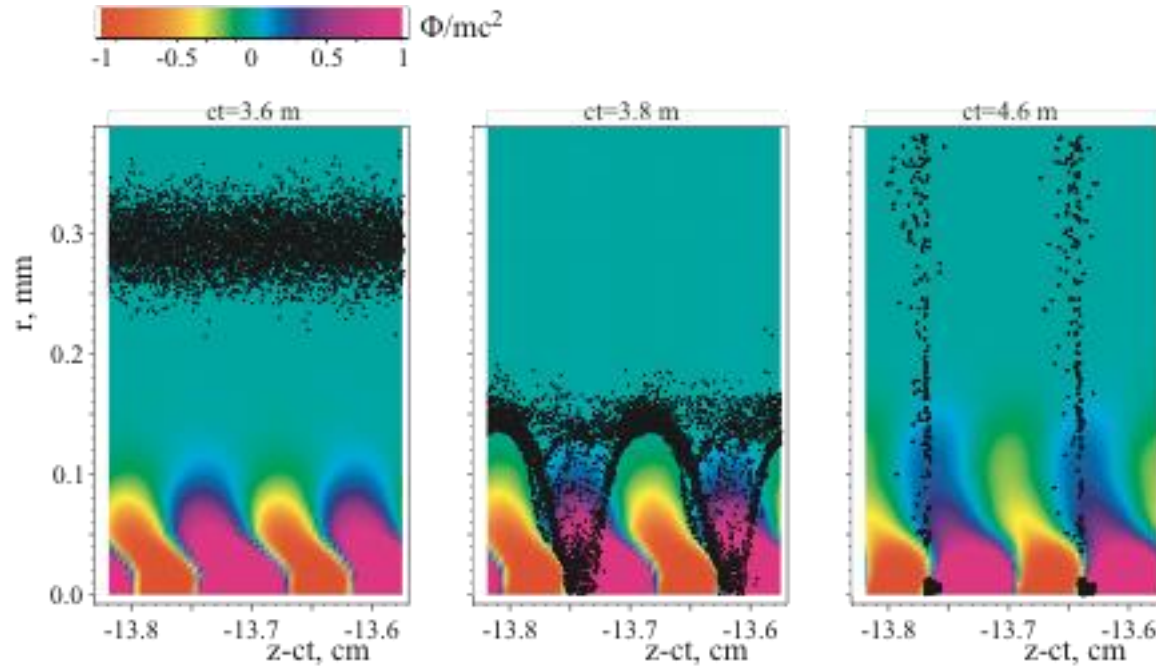

Electron bunch population,  $N_e$

Electron bunch length,  $\sigma_{ze}$

Electron bunch radius at injection point,  $\sigma_{re}$

Electron energy,  $W_e$

Electron bunch normalized emittance,  $\epsilon_{en}$

Injection angle for electron beam,  $\phi$

Injection delay relative to the laser pulse,  $\xi_0$

Intersection of beam trajectories,  $z_0$

$1.25 \times 10^9$

0.25 cm

0.02 cm

16 MeV

2 mm mrad

9 mrad

13.6 cm

3.9 m

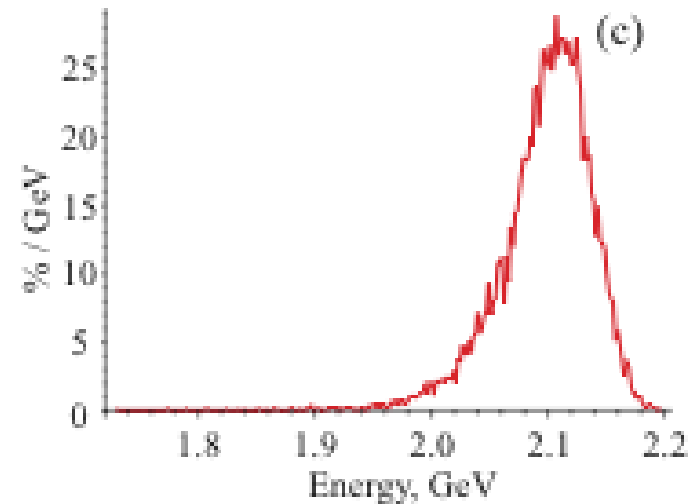

# AWAKE schematic

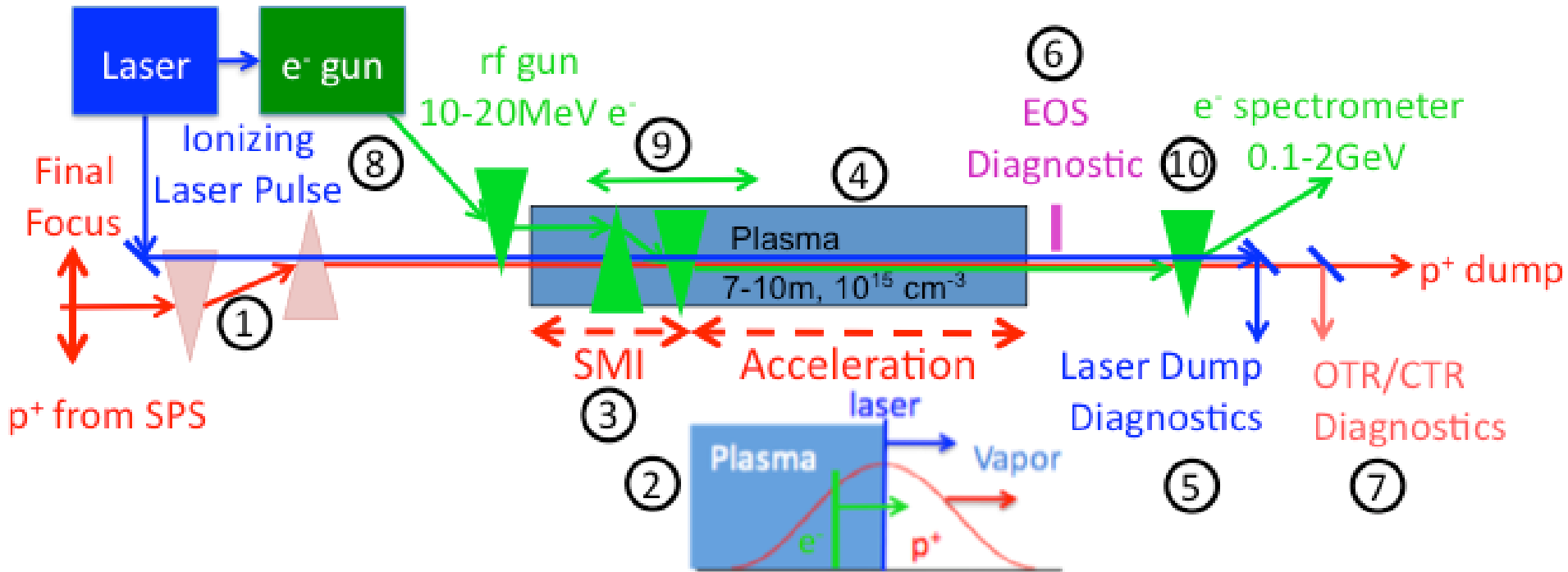

## Scientific goals

1. Demonstrate self-modulation effect of a long proton bunch and realize 1 GeV electron energy gain with a ~10 m plasma;
2. Develop and test the diagnostic equipments for the first and later experiments;
3. Benchmark data against simulation results;
4. Provide inputs for future experiment for 100 GeV energy gain in 100 m plasma.

# AWAKE Collaboration

## AWAKE collaboration:

- Several workshops, phone meetings, and site visit at CERN, strong international collaboration (communities from plasmas, accelerators and particle physics );
- Submitted Letter of Intent (LoI) in June 2011 to CERN SPSC;
- Proposal defended at SPSC meeting on June, 2011
- AWAKE Technical Design Report submitted to CERN in April 2013.

***"CERN is very interested in following and participating in novel acceleration techniques, and has as a first step agreed to make protons available for the study of proton-driven plasma wakefield acceleration."***

**CERN Leadership and  
Directorate**



# Proton Driven Plasma Wakefield Acceleration

## CERN NEUTRINOS TO GRAN SASSO Underground structures at CERN

- █ Excavated
- █ Concreted
- █ Decay tube (2nd contract)

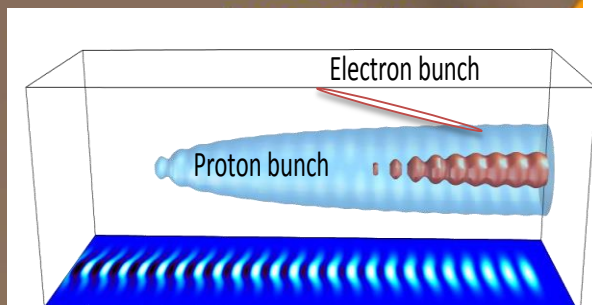
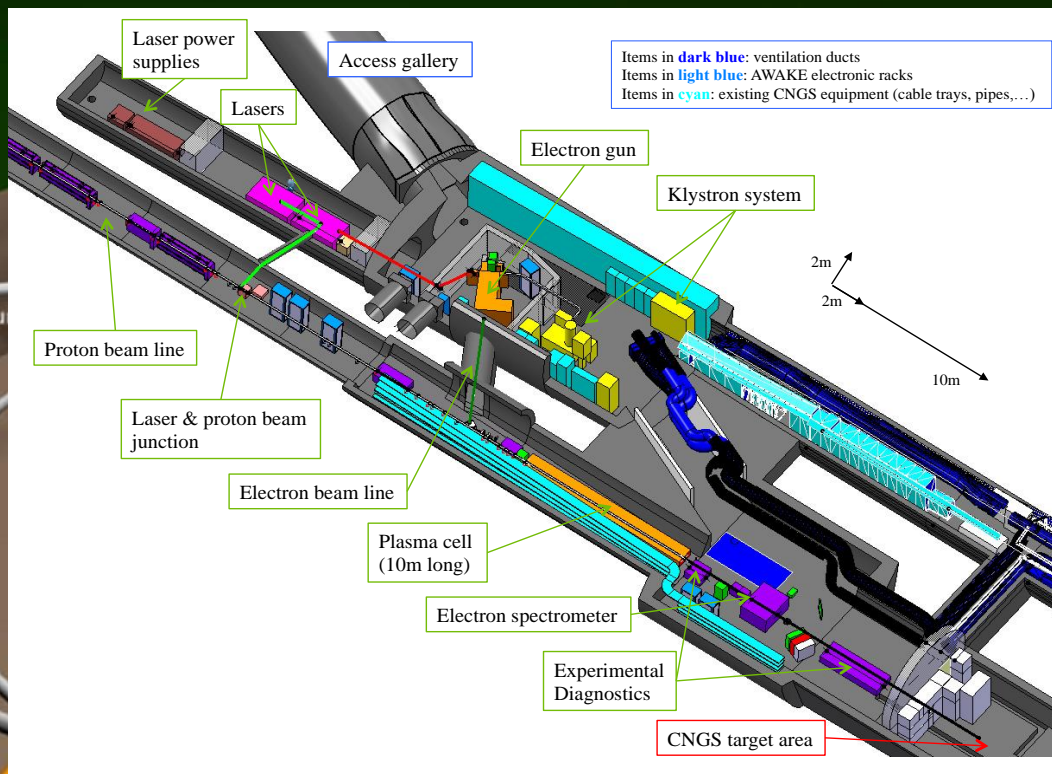
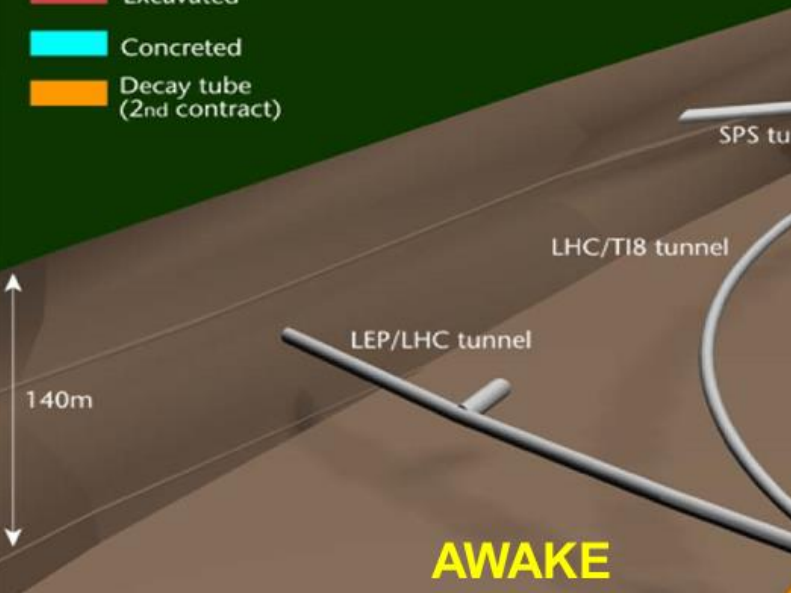

Electron acceleration based on modulated proton driven wakefield acceleration !

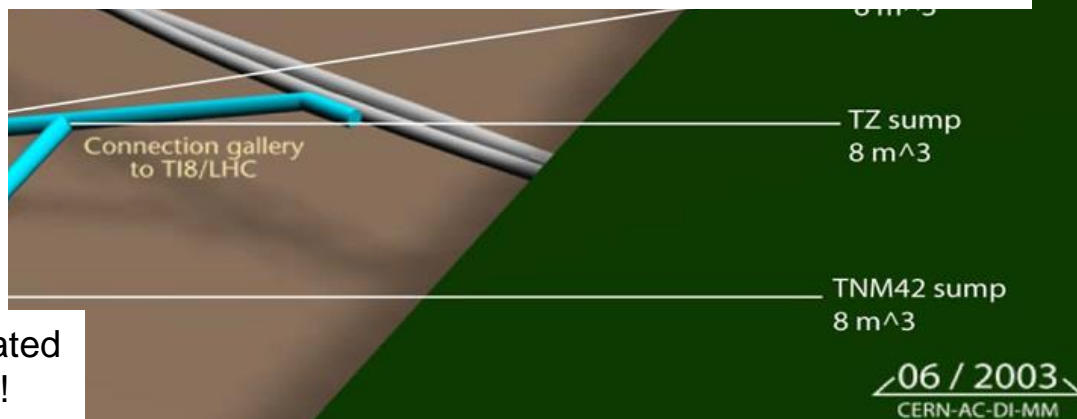

# Layout of AWAKE experiment

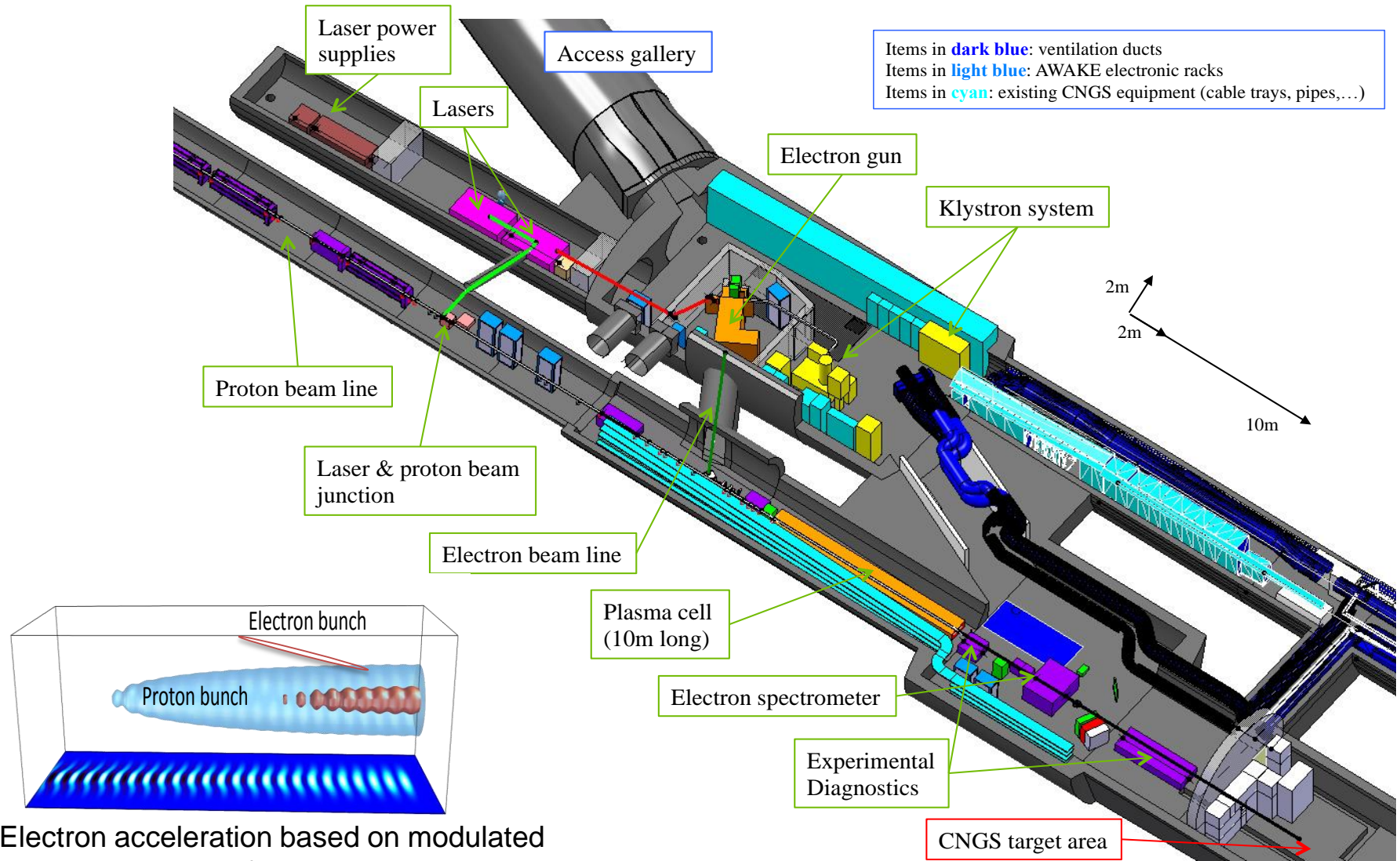



# Programme



	2013	2014	2015	2016	2017	2018	2019	2020
Proton beam-line		Study, Design, Procurement, Component preparation		Installation	Commissioning	Data taking	Data taking	Data taking
Experimental area		Modification, Civil Engineering and installation						
Electron source and beam-line		Studies, design		Fabrication	Installation	Commissioning		

1. Benchmark experiments – first experiment demonstrating proton-driven plasma wakefield acceleration
2. Detailed understanding of the self-modulation process
3. Demonstration of high-gradient acceleration of electrons
4. Develop long, scalable and uniform plasma cells; test in AWAKE experiment
5. Develop scheme for production and acceleration of short proton bunches

# AWAKE Collaboration



## AWAKE Design Report

### A Proton-Driven Plasma Wakefield Acceleration Experiment at CERN

AWAKE Collaboration



#### Abstract

The AWAKE Collaboration has been formed in order to demonstrate proton-driven plasma wakefield acceleration for the first time. This technology could lead to future colliders of high energy but of a much reduced length compared to proposed linear accelerators. The SPS proton beam in the CNGS facility

#### Institutes committed to AWAKE

- BINP, Novosibirsk, Russia
- CERN, Geneva, Switzerland
- DESY, Hamburg, Germany
- Cockcroft Institute, UK
- Heinrich Heine University, Düsseldorf (D)
- Instituto Superior Tecnico, Lisboa, Portugal
- John Adams Institute, UK
- Ludwig Maximilian University, Munich, Germany
- Max Planck Institute for Physics, Munich
- Max Planck Institute for Plasma Physics, Greifswald
- Rutherford Appleton Laboratory, Chilton, UK
- University College London, London, UK
- University of Strathclyde, Glasgow, Scotland, UK
- Northern Illinois University, USA (pending!)

Others showing interest and applying to join

**A fully approved CERN project; on their Medium-Term Plan and significant funding**

# Future collider design

## An e+ e- collider

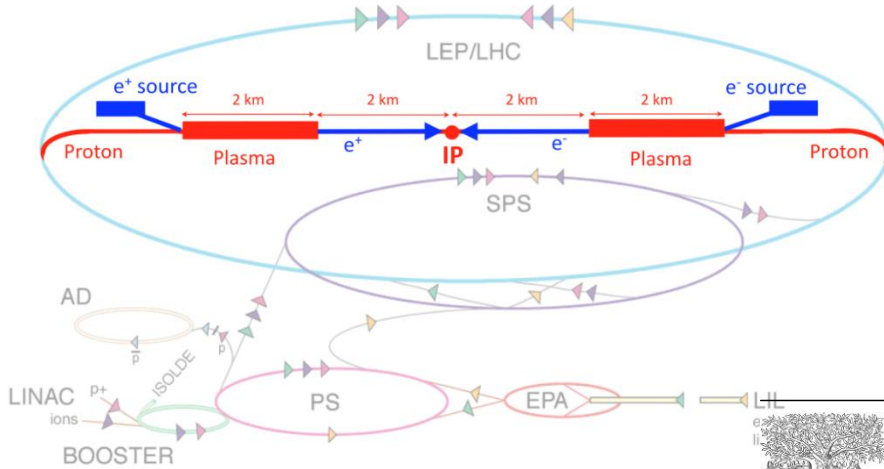

## An e-p collider

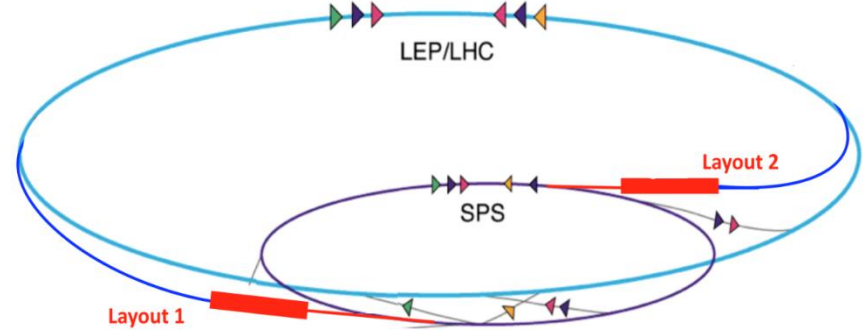

Contents lists available at [ScienceDirect](https://www.sciencedirect.com)

**Nuclear Instruments and Methods in Physics Research A**

journal homepage: [www.elsevier.com/locate/nima](http://www.elsevier.com/locate/nima)

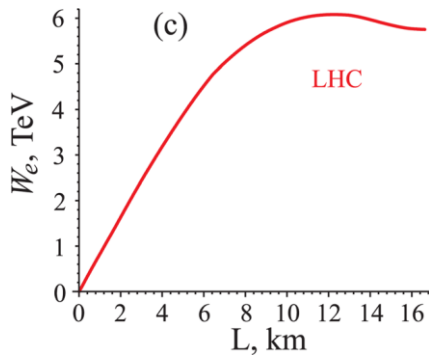

## Collider design issues based on proton-driven plasma wakefield acceleration

G. Xia<sup>a,b,\*</sup>, O. Mete<sup>a,b</sup>, A. Aimidula<sup>b,c</sup>, C.P. Welsch<sup>b,c</sup>, S. Chattopadhyay<sup>a,b,c</sup>, S. Mandry<sup>d</sup>, M. Wing<sup>d,e</sup>

<sup>a</sup> School of Physics and Astronomy, University of Manchester, Manchester, United Kingdom

<sup>b</sup> The Cockcroft Institute, Sci-Tech Daresbury, Daresbury, Warrington, United Kingdom

<sup>c</sup> The University of Liverpool, Liverpool, United Kingdom

<sup>d</sup> Department of Physics and Astronomy, University College London, London, United Kingdom

<sup>e</sup> Deutsche Elektronen-Synchrotron DESY, Hamburg, Germany

### ARTICLE INFO

**Keywords:**  
PDPWA  
Colliders  
Self-modulation instability  
Dephasing

### ABSTRACT

Recent simulations have shown that a high-energy proton bunch can excite strong plasma wakefields and accelerate a bunch of electrons to the energy frontier in a single stage of acceleration. It therefore paves the way towards a compact future collider design using the proton beams from existing high-energy proton machines, e.g. Tevatron or the LHC. This paper addresses some key issues in designing a compact electron-positron linear collider and an electron-proton collider based on the existing CERN accelerator infrastructure.

# Intensity Frontier

# Understanding Neutrinos: Fermilab Plans

Multi-MW proton beams from superconducting accelerator complex at Fermilab will impinge on targets producing unstable particles which will decay into intense and precise neutrino beams via magnetic horn techniques, directed towards an underground detector 1400 kms away in Sanford laboratory, within an abandoned mine in South Dakota, USA for short- and long-baseline neutrino experiments.

Figure-of-merit: (Mass of detector) x (Beam Power) x (Duration)

Goal for the first 10 years: 100 kT-MW-year to be achieved by 10 kT target, >1 MW beam from a superconducting linear accelerators observed over 10 years. This is the PIP-II scenario.

The Deep Underground Neutrino Experiment (DUNE) will be an international collaboration and unique in its scientific reach. Spokespersons: Andre Rubbia (ETH Zurich) and Mark Thomson (Univ. of Cambridge, UK)

Mid-term strategy for > 2 MW beam power after PIP-II depends on various choices.

# Evolution of Fermilab Campus

Linac: MTA

BNB: MicroBooNE

NuMI: MINOS+, MINERvA, NOvA

Fixed Target: SeaQuest, Test Beam Facility, M-Center

Muon: g-2, Mu2e (future)

DUNE: Short- and Long-baseline Neutrinos  
PIP, PIP-II, PIP-III (future)

Also, test and R&D facilities:

ILC Cryomodule

IOTA

SRF

Cryo

PXIE

## Fermilab Accelerator Complex

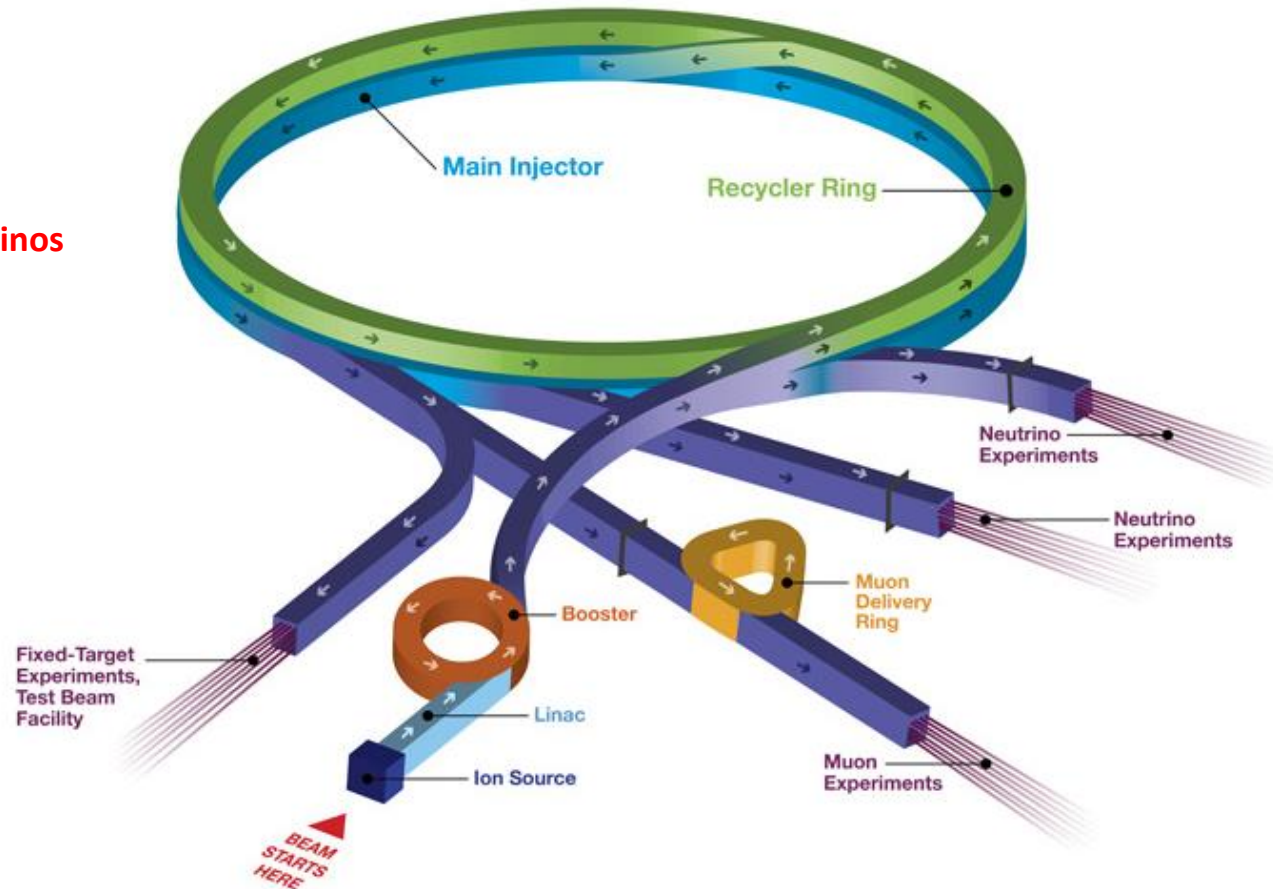

# Accelerator Complex Now

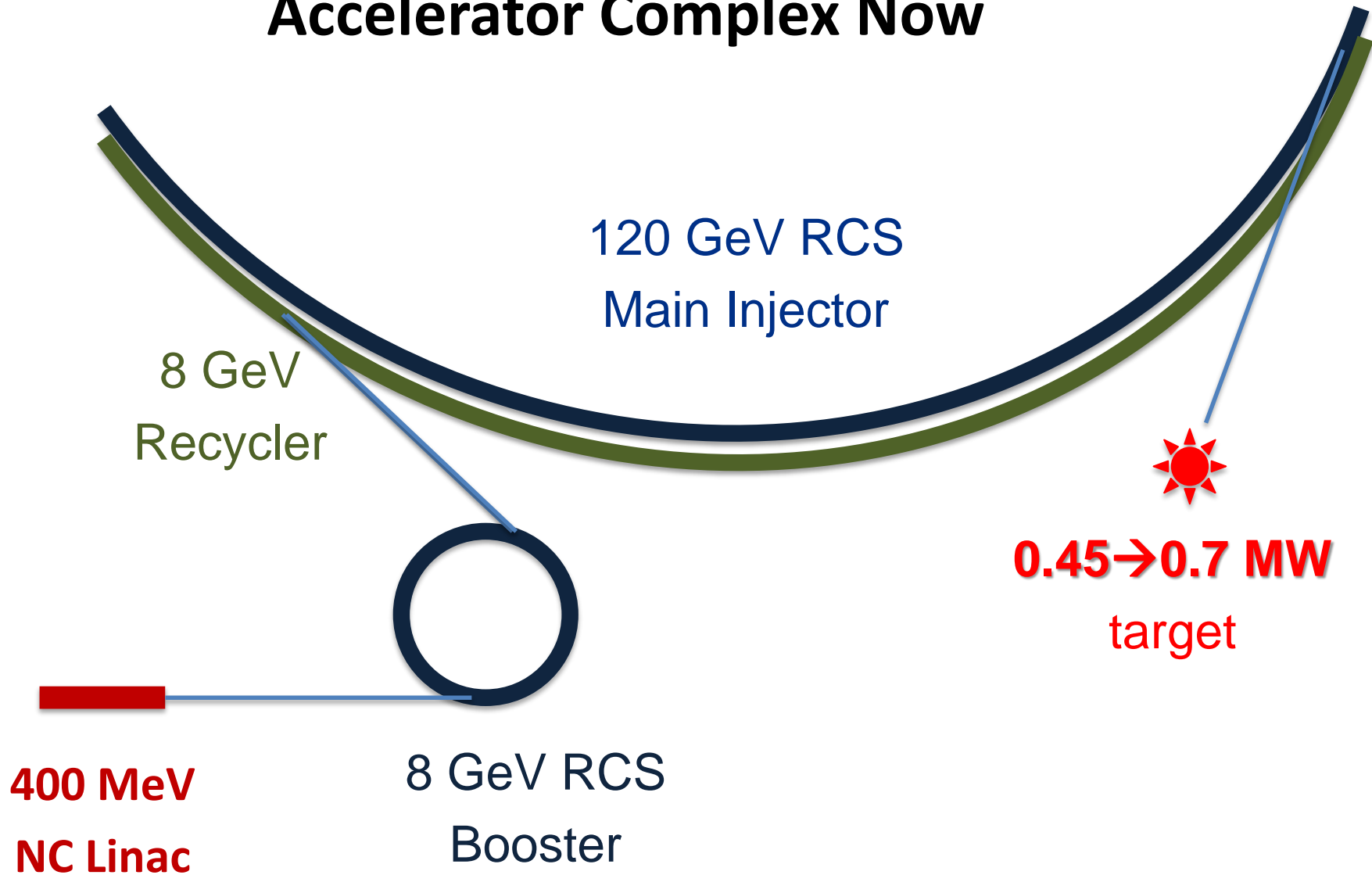

# “Near future”, PIP-II , ca 2023-24

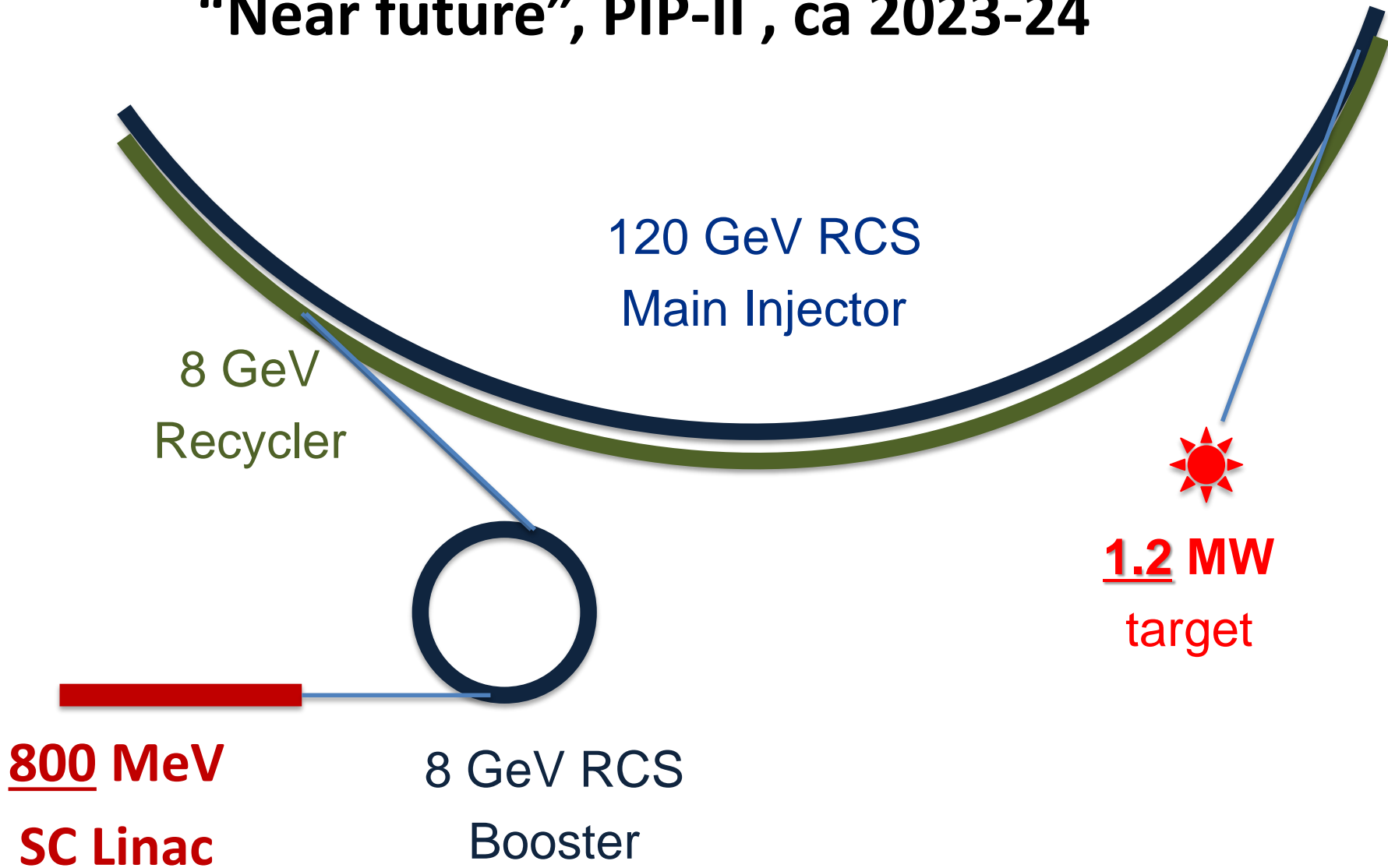



# Beyond PIP-II

## PIP-II

## Beyond PIP-II (mid-term)

	1st 10 years	2nd 10 years		
To Achieve :	100 kT-MW-year	500 kT-MW-year		
We combine :		Option 1	Option 2	Option 3
Mass	10 kT	50 kT	20 kT	10 kT
Power	1 MW	1 MW	2.5 MW	5 MW

- **Mid-term** strategy after PIP-II depends on the technical feasibility of each option and the analysis of **costs/kiloton versus costs/MW**
- **Superconducting linear accelerators and high power targets are expensive --- need cost-effective solutions!!!**

# PIP-III “multi-MW” - Option B: 8 GeV linac

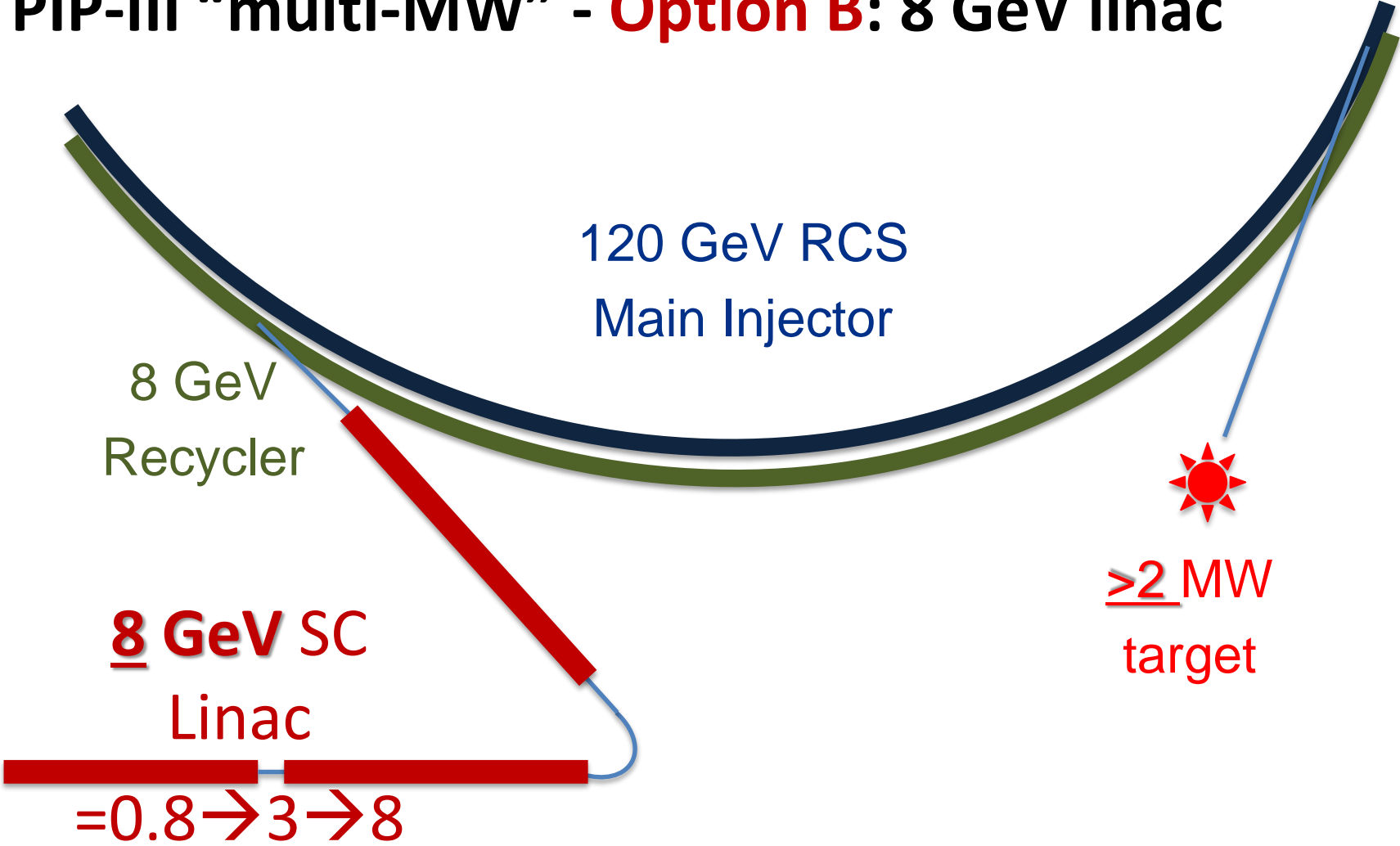

# PIP-III “multi-MW”- **Option A: 8+ GeV smart RCS**

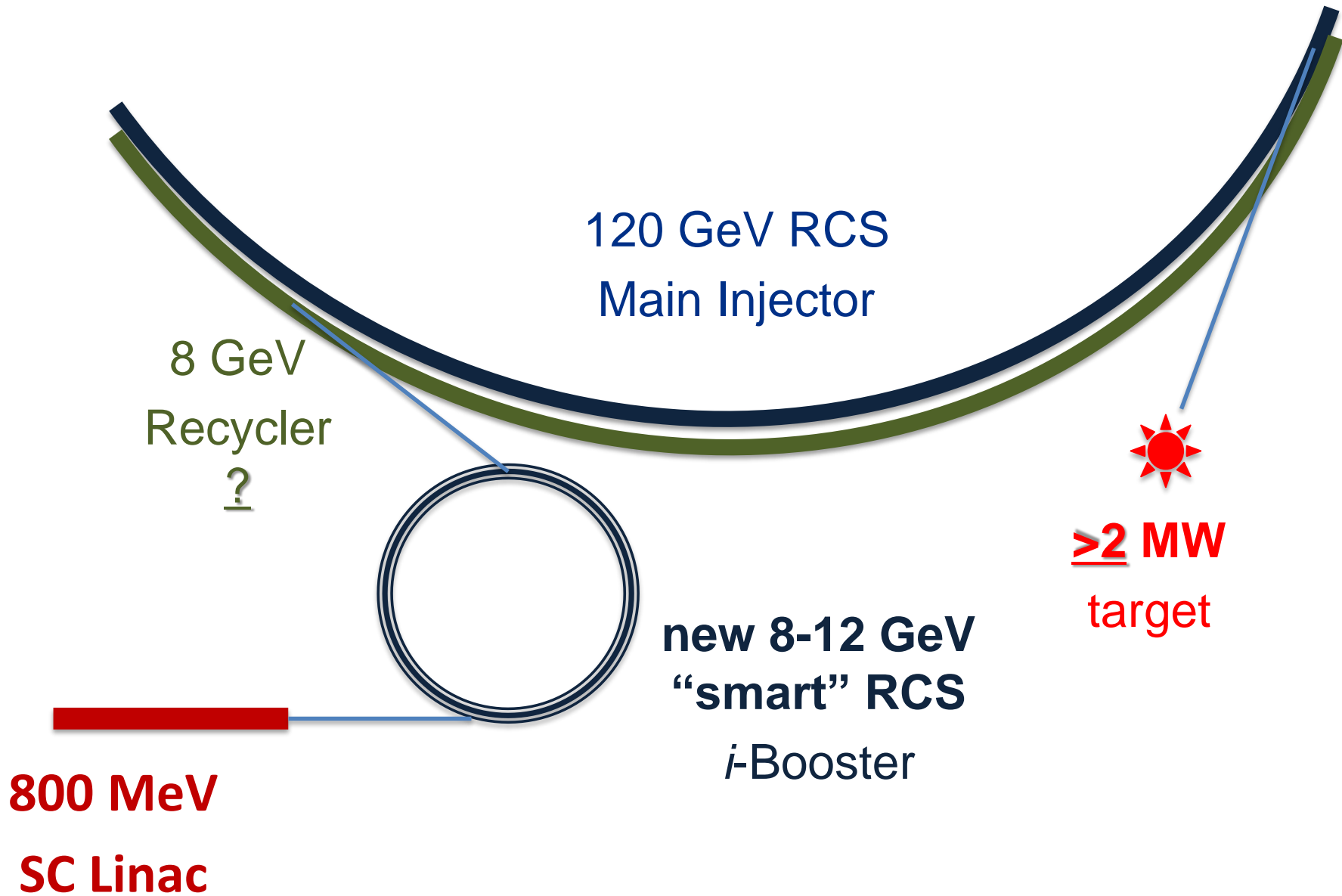

## PIP-III: Intelligent choice requires analysis and R&D

- **Either** increase performance of the synchrotrons by a **factor of 3-4**:
  - E.g.  $dQ_{sc} > 1$  → **need R&D**
  - Instabilities/losses/RF/injection/collimation
  - IOTA/FAST is being built to study new methods
- **Or** reduce cost of the **SRF / GeV** by a **factor of 3-4**:
  - Several opportunities → **need R&D**
  - (comprehensive program proposed by TD)
- **And** – in any scenario – develop **multi-MW** targets:
  - They do not exist now → extensive **R&D needed**

# IOTA schematic

2.5 MeV  $p^+$  or 150 MeV  $e^-$  / 40 m

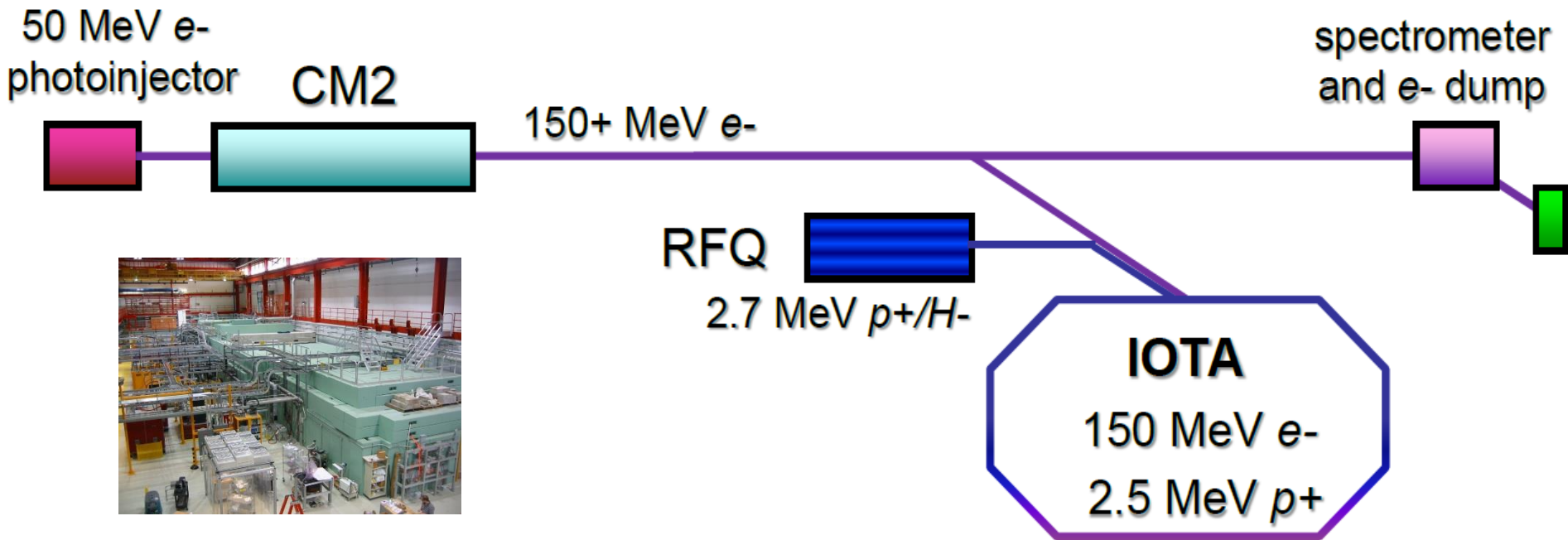

**IOTA** under construction at Fermilab →

**Excellent opportunity for PhD research in nonlinear dynamics!!!!**

*A Mathematical  
Detour*

# Integrable nonlinear focusing

- Look for second integrals quadratic in momentum
  - First comprehensive study by Gaston Darboux (1901)
- So, we are looking for integrable potentials such that

$$H = \frac{p_x^2 + p_y^2}{2} + \frac{x^2 + y^2}{2} + U(x, y)$$

Second integral:  $I = Ap_x^2 + Bp_x p_y + Cp_y^2 + D(x, y)$

$$A = ay^2 + c^2,$$

$$B = -2axy,$$

$$C = ax^2,$$

# Darboux equation

- **General solution**

$$U(x, y) = \frac{f(\xi) + g(\eta)}{\xi^2 - \eta^2}$$

$$\xi = \frac{\sqrt{(x+c)^2 + y^2} + \sqrt{(x-c)^2 + y^2}}{2c}$$
$$\eta = \frac{\sqrt{(x+c)^2 + y^2} - \sqrt{(x-c)^2 + y^2}}{2c}$$

$\xi : [1, \infty]$ ,  $\eta : [-1, 1]$ ,  $f$  and  $g$  arbitrary functions



**Look for the potential to be also physically realizable:  
Laplace equation for external fields and Poisson's  
equation for "space-charge"!!**

- Satisfy the Laplace equation (in addition to the Darboux equation):

$$U_{xx} + U_{yy} = 0$$

- We found a family with 4 free parameters (b, c, d, t):

$$f_2(\xi) = \xi \sqrt{\xi^2 - 1} (d + t \operatorname{acosh}(\xi))$$

$$g_2(\eta) = \eta \sqrt{1 - \eta^2} (b + t \operatorname{acos}(\eta))$$

$$U(x, y) = \frac{f(\xi) + g(\eta)}{\xi^2 - \eta^2}$$

# Examples of potentials

- $c$  – location of singularities on x-axis ( $x = +/- c$ )
- $t$ ,  $b$  and  $d$  define the type of the potential
  - There are 3 possible types and (their combinations)

$$t = 0, d = 0$$

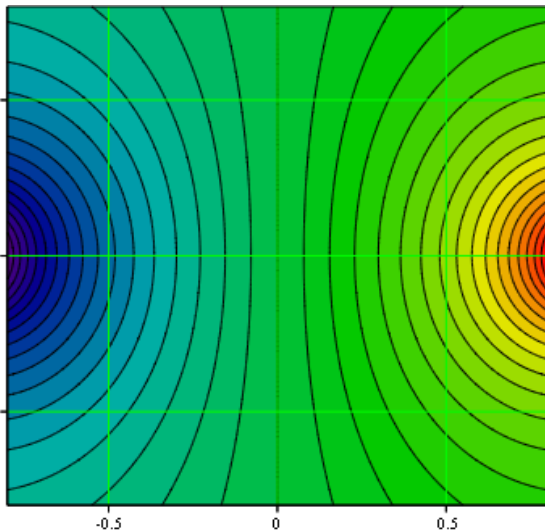

Dipole-like

$$t = 0, b = 0$$

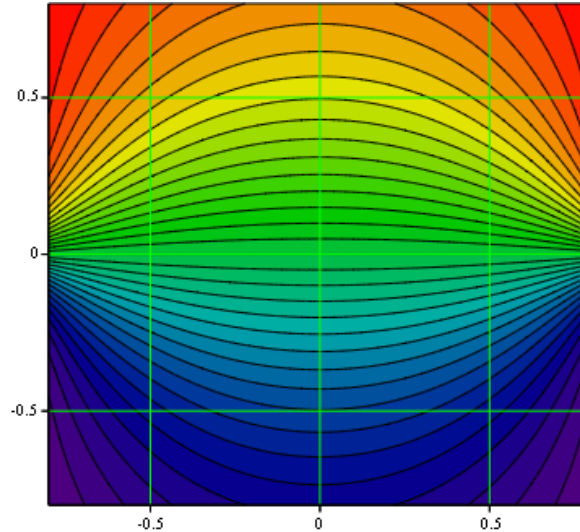

Dipole-like

$$d = 0 \text{ and } b = -\frac{\pi}{2}t$$

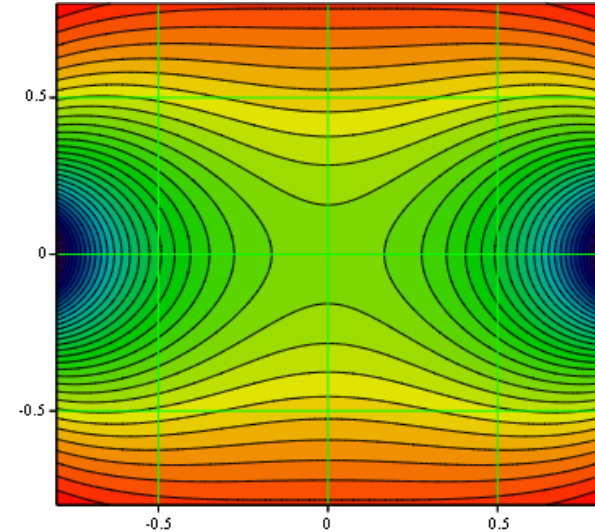

Quad-like

# Nonlinear lens

$$H = \frac{p_x^2 + p_y^2}{2} + \frac{x^2 + y^2}{2} + U(x, y)$$

This potential has two adjustable parameters  
 $t$  – strength and  $c$  – location of singularities

Multipole expansion (electrostatic case):

$$\text{For } |z| < c \ U(x, y) \approx \frac{t}{c^2} \operatorname{Re} \left( (x+iy)^2 + \frac{2}{3c^2} (x+iy)^4 + \frac{8}{15c^4} (x+iy)^6 + \frac{16}{35c^6} (x+iy)^8 + \dots \right)$$

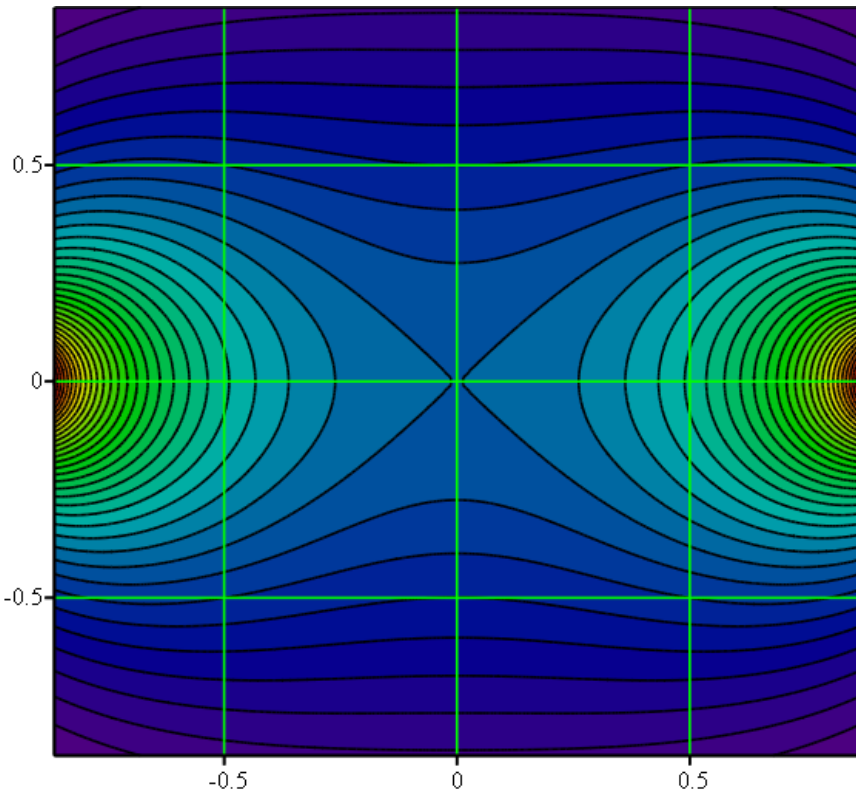

For  $c = 1$

$|t| < 0.5$  to provide linear stability for small amplitudes

For  $t > 0$  adds focusing in  $x$

Small-amplitude tune  $s$ :

$$\nu_1 = \sqrt{1 + 2t}$$

$$\nu_2 = \sqrt{1 - 2t}$$

# Space Charge Dynamics in Non-Linear Integrable Optics

$$\Delta Q_{sc} \sim -0.7$$

Tech-X, RadiaSoft simulation

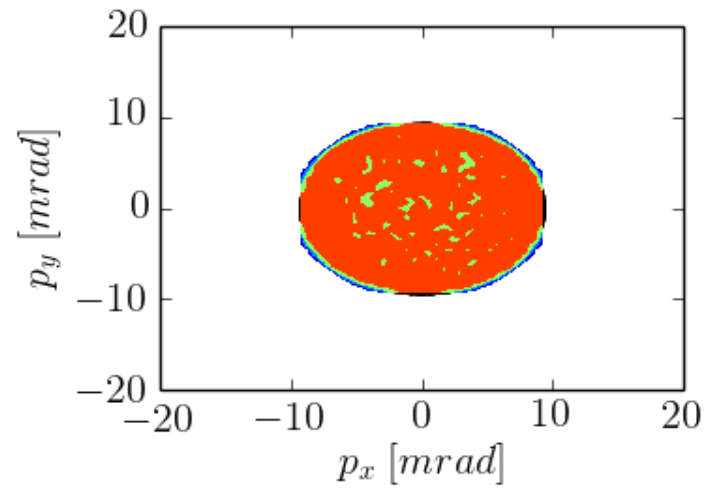
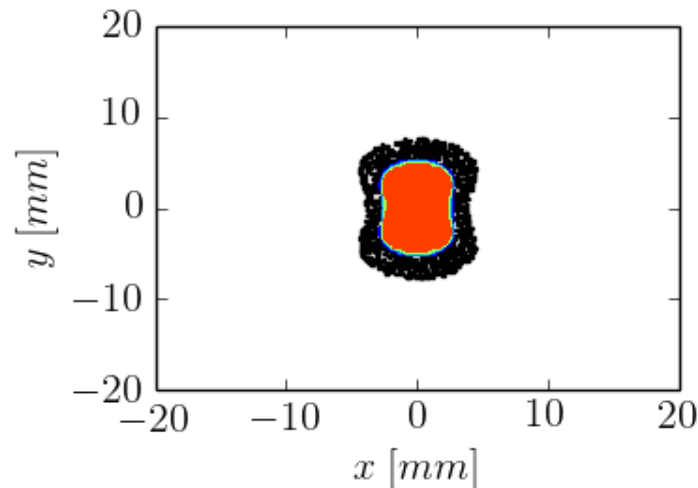
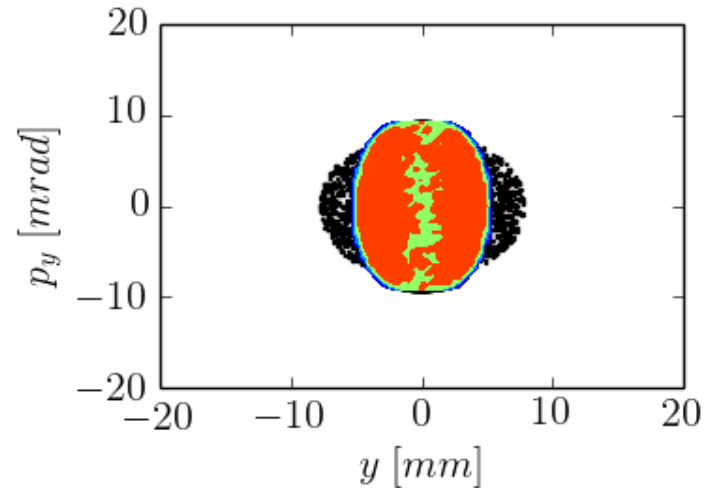
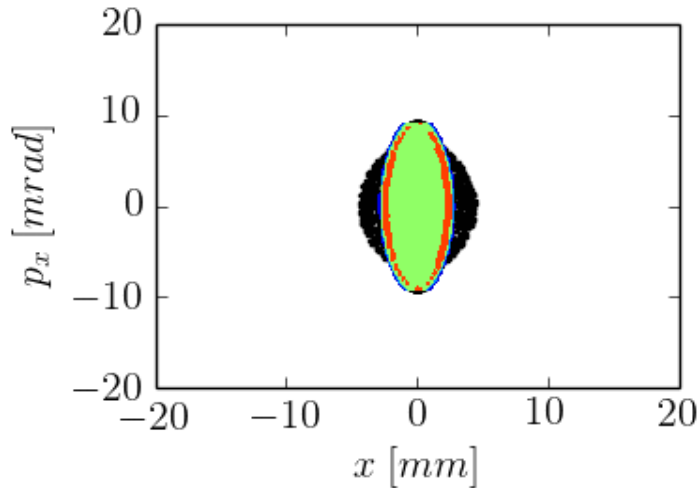

# The list of IOTA Experiments Towards PIP-III

- **E1-3: Integrable Optics**
  - #1: IO with non-linear magnets, test with electrons
  - #2: IO with non-linear magnets, test with protons
  - #3: IO with e-lens(es), tests with protons
- **E4-5: Space-Charge Compensation**
  - #4: SCC with e-lens(es), test with protons
  - #5: SCC with e-columns, tests protons



# Precision Frontier



# Fermilab Muon Campus



A new campus at Fermilab is being constructed to host the next generation of muon experiments e.g. the new "*g*-2" and "Mu2e" experiments will be housed in this campus (MC-1 building shown will house the "*g*-2").



# The “Mu2e” Experiment:

## Muon to Electron Conversion

- The “Mu2e” experiment at Fermilab will search for the conversion of a muon to an electron in the field of a nucleus

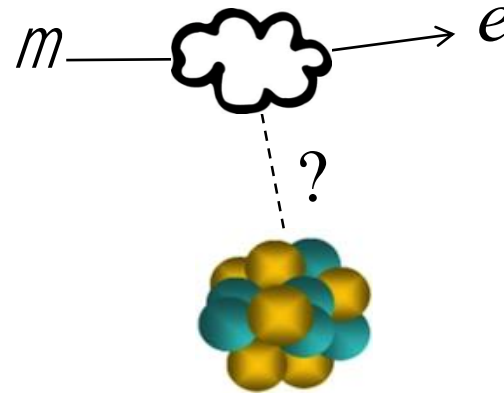
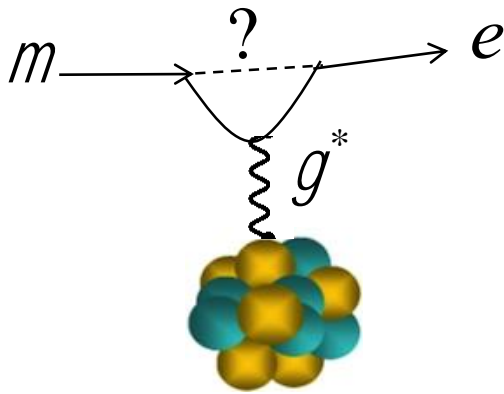

- Can happen in the Standard Model through virtual neutrino mixing, but at a level *far* too small to be observed.
- An almost universal feature of physics models beyond the Standard Model.
- Any observed signal would be unambiguous evidence of new physics.
- Mu2e plans to be roughly 10,000 times more sensitive to this conversion than the best previous measurement.

# Experimental Technique and Beam Requirements

- An 8 GeV proton beam will strike a production target to produce muons.
  - A solenoidal magnetic channel will transport muons to a target, where most of the muons will be captured on Aluminum nuclei.
  - If a captured muon converts, the resulting electron will carry most of the muon's rest energy, resulting in a striking experimental signature of a mono-energetic electron.
- **The experiment requires short pulses of protons to produce muons, separated by enough time to wait for conversions.**
  - **To reduce backgrounds, there must be nothing between the pulses at the  $10^{-10}$  level (“extinction”)**

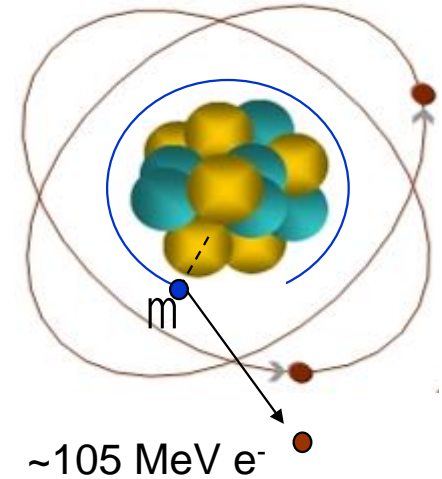

# Mu2e Proton Delivery

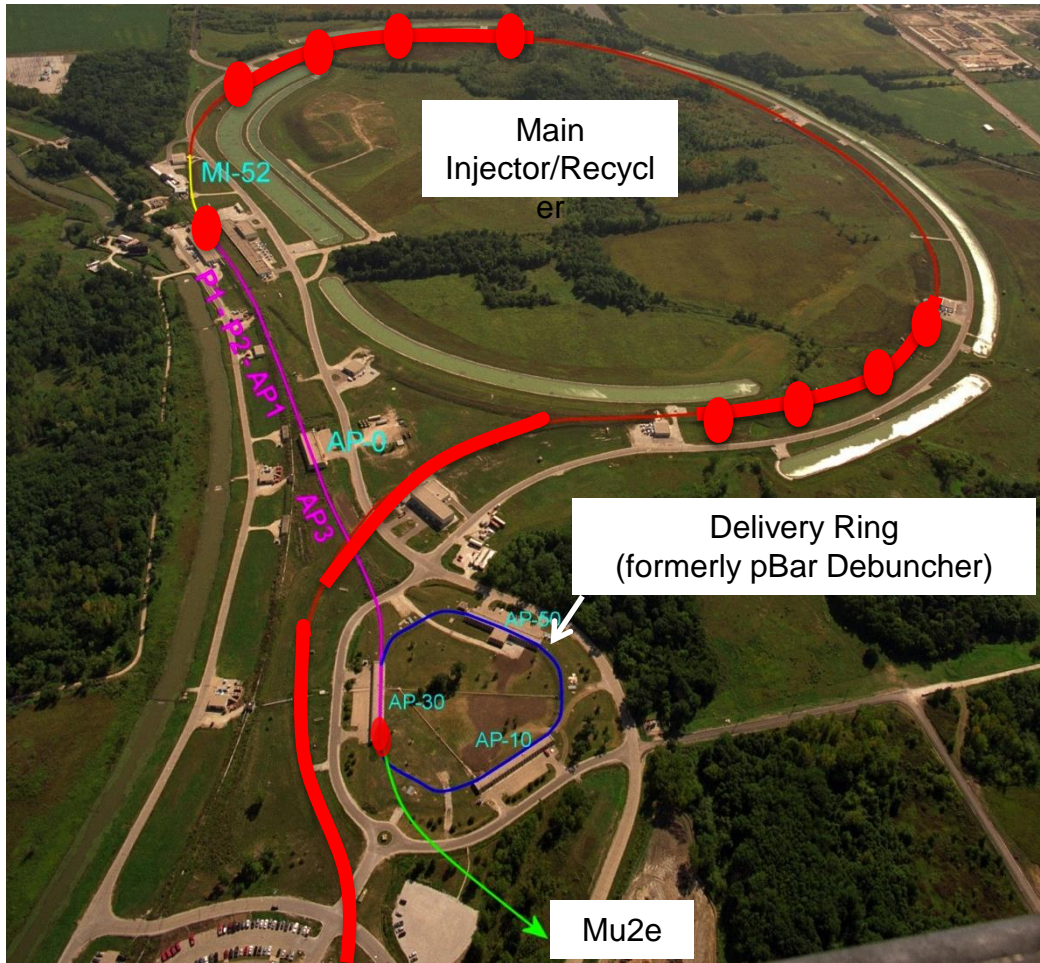

Booster

- One Booster “batch” is injected into the Recycler (8 GeV storage ring).
  - $4 \times 10^{12}$  protons
  - 1.7  $\mu\text{sec}$  long
- It is divided into 4 bunches of  $10^{12}$  each
- These are extracted one at a time to the Delivery Ring
  - Period = 1.7  $\mu\text{sec}$
- As a bunch circulates, it is resonantly extracted to produce the desired beam structure.
  - Bunches of  $\sim 3 \times 10^7$  protons each
  - Separated by 1.7  $\mu\text{sec}$

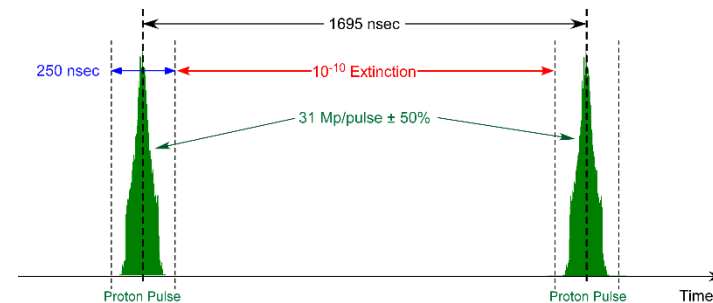

# Mu2e Accelerator Physics Challenges

- **Overall beam quality**
  - Supporting Mu2e along with other experiments will push the limits of the Fermilab Linac and Booster, many components of which are original to the lab (i.e. about 45 years old).
  - Keeping up with new demands is an ongoing effort.
- **Halo and beam loss control.**
  - The pBar enclosure was designed for several orders of magnitude less beam, and so has very little shielding.
  - Beam loss must be carefully controlled and monitored to allow the experiment to run within radiation limits.
- **Resonant extraction.**
  - The experiment requires that resonant extraction be established quickly (5 ms) and extract beam with very uniform bunch intensity.
- **Beam extinction**
  - Bunch formation in Recycler and Delivery Ring
  - Active extinction system in beam line, consisting of a combination of resonant magnets and collimators, such that only in-time beam passes through.
  - Monitoring that the required level of extinction has been achieved also presents a challenge.



<http://muon-g-2.fnal.gov>



**The “g-2” Experiment:  
Measuring the  
Anomalous Muon  
Gyromagnetic Ratio:  
A Window to New  
Physics**



# Magnetic Moments for Particles

$$L = mvr$$

$$\Rightarrow \vec{\mu} = \frac{q}{2m} \vec{L}$$

$$S = \frac{\hbar}{2}$$

~~$$\vec{\mu} = \frac{e}{2m} \vec{s}$$~~

Wrong!

$$\vec{\mu}_e = g \frac{e}{2m_e} \vec{s}$$

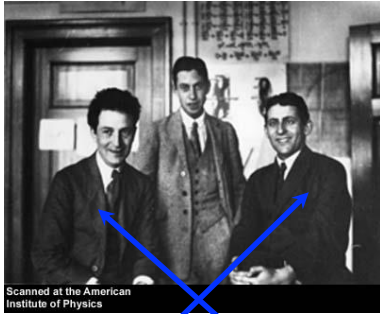
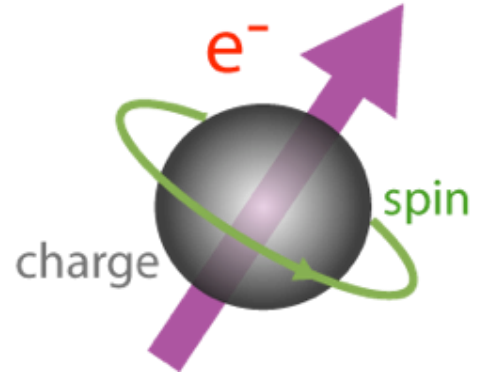

Fitting to data resulted in a "best fit"  $g$  value (for electron) of 2!

Uhlenbeck and Goudsmit, Naturwiss 47, 953 (1925)

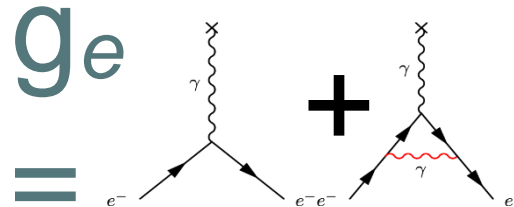

Schwinger, Phys. Rev. 73, 416 (1948)

Not Quite: QED corrections

First order QED corrections

$$g_e \approx 2 \left( 1 + \frac{\alpha}{2\pi} \right) \approx 2.00232$$



# The “Anomalous” Magnetic Moment

$$a = \frac{g - 2}{2}$$

## Current Status for $a_e$ :

$$a_e^{exp} = 1\,159\,652\,180.73(28) \times 10^{-12}$$

$$a_e^{th} = 1\,159\,652\,181.78(77) \times 10^{-12}$$

$$\Rightarrow \Delta a_e = (1.05 \pm 0.82) \times 10^{-12}$$

Agreement is to part-per-trillion level! Refinements possible, but no easy “order of magnitude” improvements are on the horizon.

Next logical step is to look at the magnetic moment of the muon. Lifetime is 2.2  $\mu$ s, so it is possible to measure  $\sim 200$  times heavier than electron, so (naively) should be  $200^2$  times more sensitive to new particles in loops

Who Ordered That?

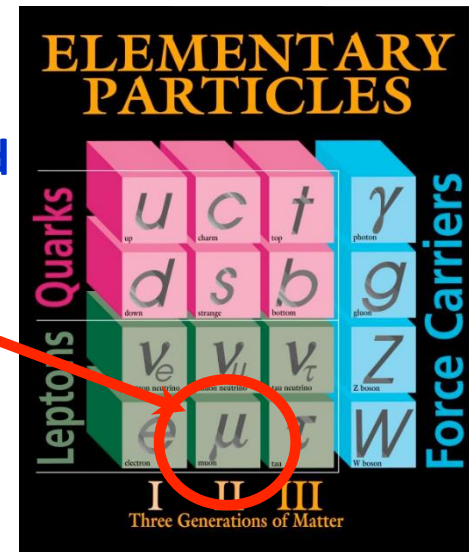
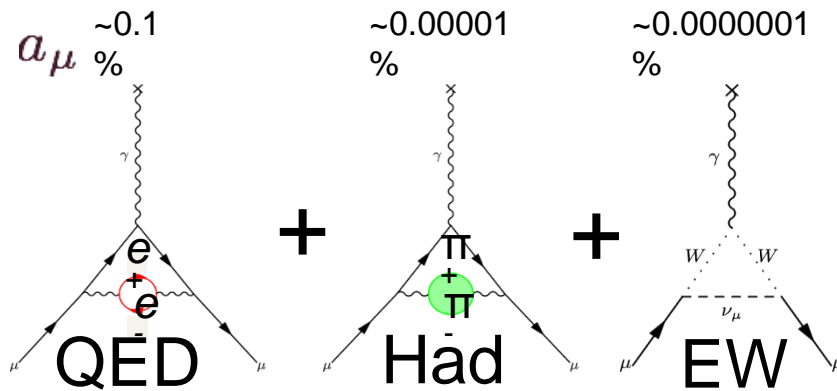



# Measuring $a_\mu$ In a Storage Ring

In a storage ring, muons circulate at the cyclotron frequency. Spin is precessing at the Larmor frequency. What is measured experimentally ( $\omega_a$ ) is the difference between these, which provides a direct measure of  $a_\mu$

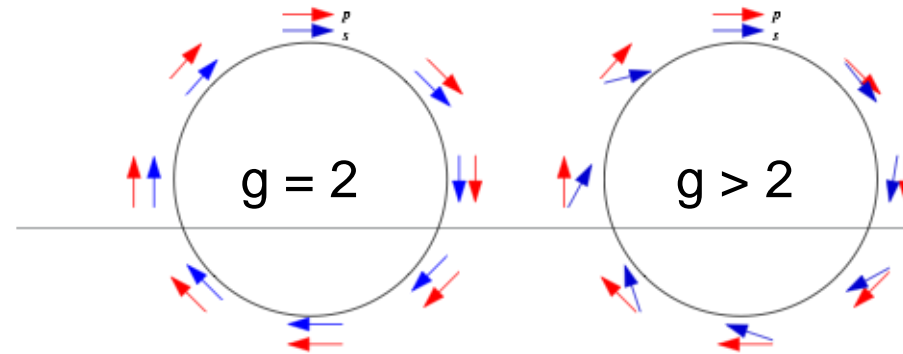

$$\omega_c = \frac{eB}{mc}$$

$$\omega_s = g \frac{eB}{2mc}$$

$$\omega_a = \omega_s - \omega_c$$

$$\omega_a = a_\mu \frac{eB}{mc}$$

## The Magic Momentum

Muons bent into a circle with a magnetic field in the storage ring. But, beam focusing is also needed. Done with electrostatic quadrupoles. In the presence of electric and magnetic fields,

$$\vec{\omega}_a = \frac{e}{mc} \left[ a \vec{B} - \left( a - \frac{1}{\gamma^2 - 1} \right) \vec{\beta} \times \vec{E} \right]$$

Choosing  $\gamma=29.3$  ( $p=3.09$  GeV) cancels out E-field term!





# Current best measurement of $a_\mu$ from E-821 experiment at Brookhaven National Lab

## A muon storage ring with 1.4 T superconducting coils, 50 ft in diameter

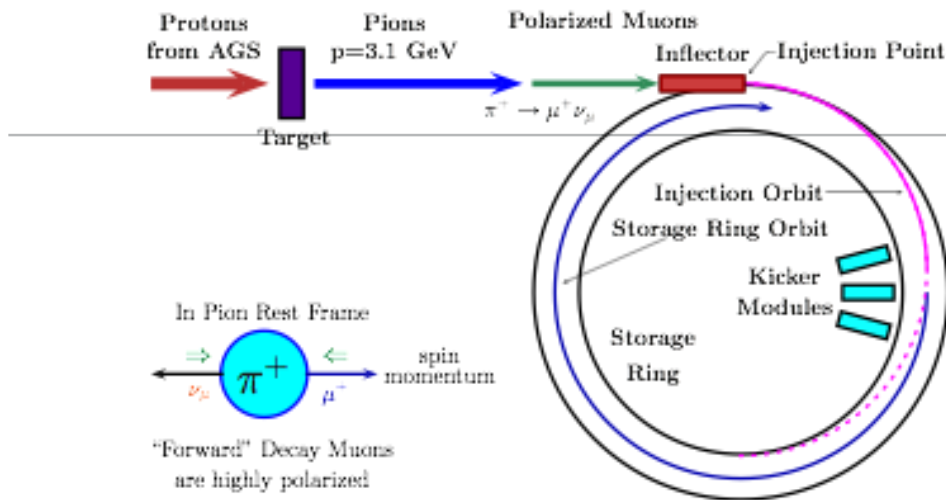

# BNL measurement of $a_\mu$ from E-821 experiment at Brookhaven National Laboratory limited by field non-uniformities and nonlinear resonances

Modulation is due to  $\omega_a$   
(all calorimeters)

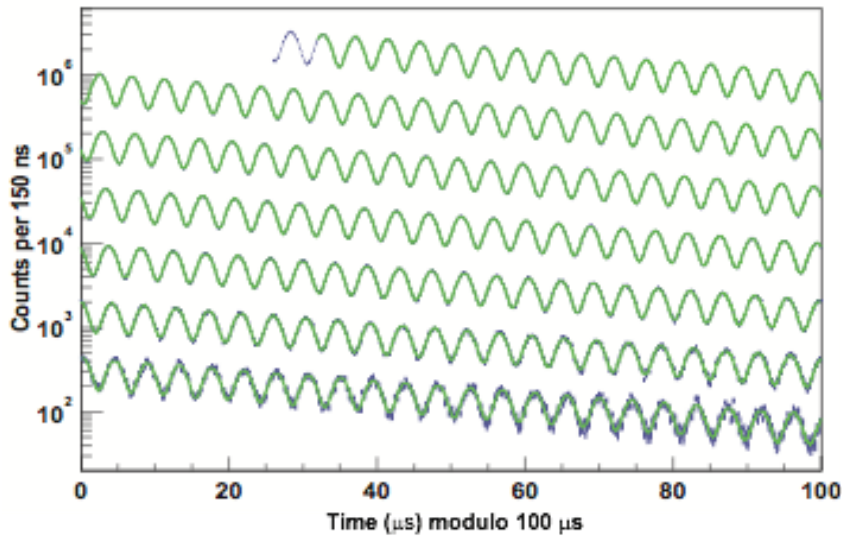

Phys. Rev. D 73, 072003 (2008)

**Final Result**

$$a_\mu = 116\,592\,089(63) \times 10^{-11}$$

**0.54 ppm!**

**$3\sigma$  discrepancy from SM prediction!**

## History of the measurement

TABLE I. Summary of  $a_\mu$  results from CERN and BNL, showing the evolution of experimental precision over time. The average is obtained from the 1999, 2000 and 2001 data sets only.

Experiment	Years	Polarity	$a_\mu \times 10^{10}$	Precision (ppm)	Reference
CERN I	1961	$\mu^+$	11450000(220000)	4300	[2]
CERN II	1962–1968	$\mu^+$	11661600(3100)	270	[3]
CERN III	1974–1976	$\mu^+$	11659100(110)	10	[5]
CERN III	1975–1976	$\mu^-$	11659360(120)	10	[5]
BNL	1997	$\mu^+$	11659251(150)	13	[6]
BNL	1998	$\mu^+$	11659191(59)	5	[7]
BNL	1999	$\mu^-$	11659202(15)	1.3	[8]
BNL	2000	$\mu^+$	11659204(9)	0.73	[9]
BNL	2001	$\mu^-$	11659214(9)	0.72	[10]
Average			11659208.0(6.3)	0.54	[10]

## Data for one calorimeter

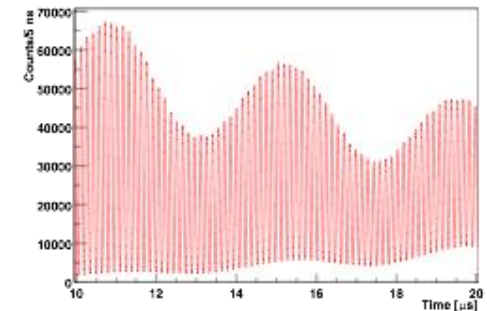

FIG. 19 (color online). Intensity at a single detector station shortly after injection. The rapid modulation repeats at the cyclotron frequency as the muon bunch circles the ring. The width of the bunch grows with time because of the finite  $\delta p/p$  of the stored muons. The slow variation in the maximum amplitude is at the  $(g - 2)$  frequency.

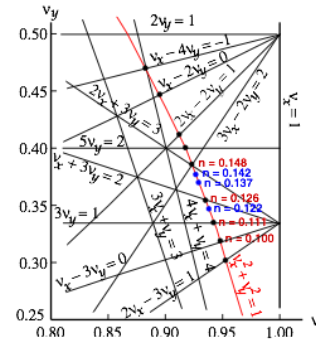

FIG. 18 (color online). The tune plane showing resonance lines. Three of the  $n$  values used to run the experiment, 0.122, 0.137, 0.142, are indicated on the arc of the circle defined as  $v_x^2 + v_y^2 = 1$ . They do not intersect any of the resonance lines, contrary to nearby tunes, which are also shown on the arc.

# E-989: The New Muon $g-2$ Measurement at Fermilab



## Why Fermilab?



- Fermilab is able to produce many more muons, than Brookhaven
- Fermilab is able to produce “better” muons than Brookhaven
  - Much less pion contamination makes it into the ring
- Improved detector and magnetic field control in the Technical Design Report
- Improve  $a_\mu$  measurement to 0.14 ppm
  - Assuming central values unchanged, will result in  $5\sigma$  experimental/theoretical discrepancy

The “g-2”

Collaboration is

Global (includes UK)

~100 physicists

~30 institutions

7 countries

# The Big Move

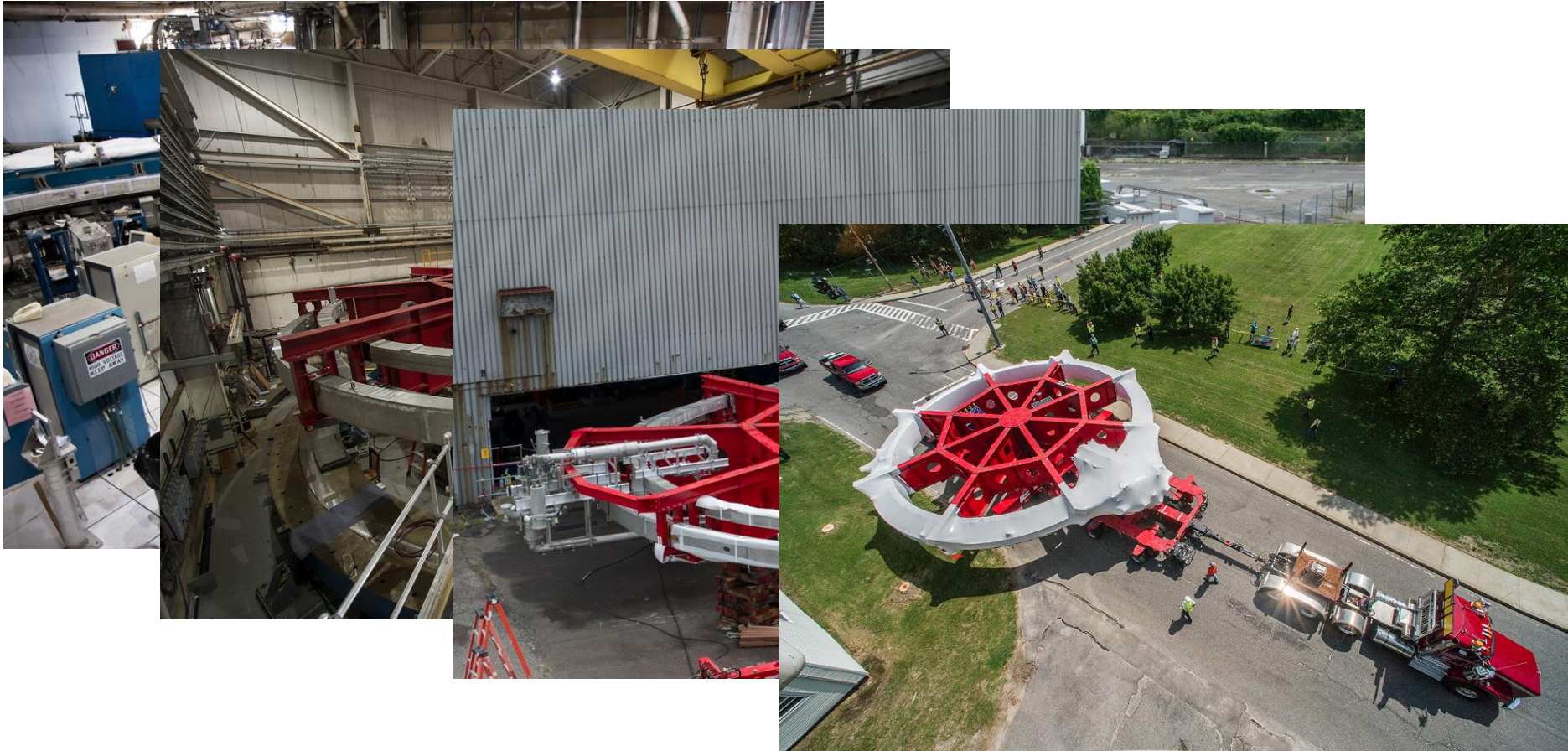

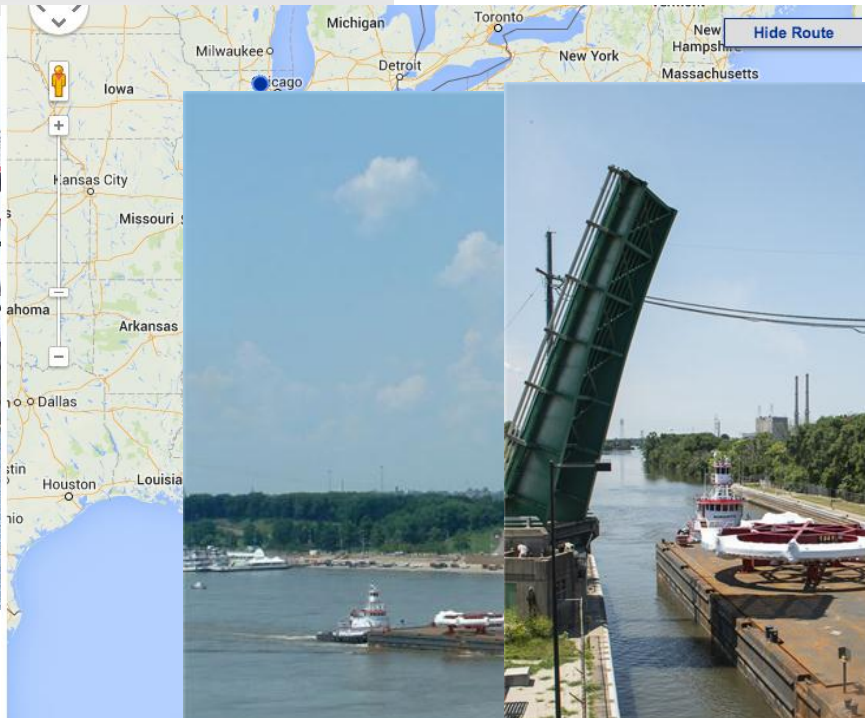



# Cosmic Frontier

# ***-Introduction***

The standard model is a successful description of the particle physics we have observed however there are many phenomena that cannot be explained (based upon solar corona, transparency etc.)

- Only 4% is ‘baryonic’ matter
- 26 % is “Dark Matter” DM
- 70 % is “Dark Energy” DE

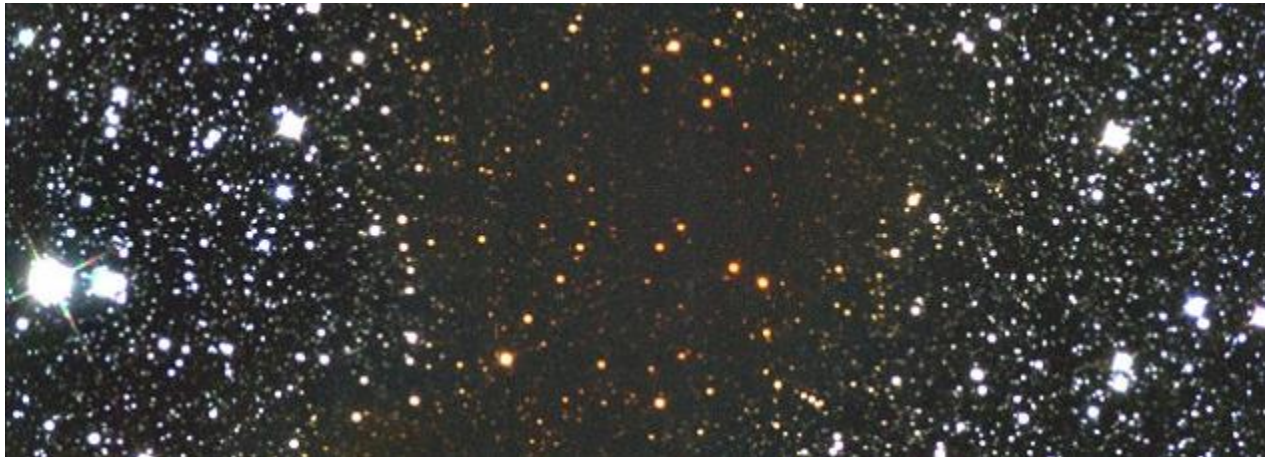

Hidden Sector Photon(HSP) and/or Axions are among many prime candidates for DM



# RF cavity search for “dark matter” hidden sector photons

## *Example:* The CASCADE Collaboration

- Cockcroft Institute
  - I. Bailey, G. Burt, A. Dexter, M. Kalliokoski, N. Woollett
  - S. Chattopadhyay, J. Dainton
  - P. Goudket, S. Jamison, S. Pattalwar, T. Thakker, P. Williams
- CERN
  - M. Betz, F. Caspers

# -The Hidden Sector

The hidden sector photon(HSP) refers to the spin 1 gauge boson associated with an additional U(1) field.

$$\mathcal{L} = \underbrace{-\frac{1}{4} F^{\mu\nu} F_{\mu\nu}}_{\text{Electromagnetic Field}} \underbrace{-\frac{1}{4} B^{\mu\nu} B_{\mu\nu}}_{\text{HSP Field}} \underbrace{-\frac{1}{2} \chi F^{\mu\nu} B_{\mu\nu}}_{\text{Kinetic Mixing Term}} + \underbrace{\frac{1}{2} m_{\gamma'}^2 B_\mu B^\mu}_{\text{HSP Mass Term}}$$

The HSP couples weakly to SM U(1) through kinetic mixing similar to neutrino flavour oscillations.

To be observable the HSP needs to have mass.

# *-HSP can couple two cavities*

- HSPs can transport energy to regions forbidden to photons.
- This allows the HSP to excite the EM field inside a perfectly shielded box.
- Conversely a box shielded to contain an electric field can lose energy via the HSP field.
- At microwave frequencies UWA , Yale and CERN have experiments and at optical frequencies ALPs is the leading experiment.
- **Probability: 10 E-25**



- The probability for this process is  $\mathcal{P} = \frac{P_{det}}{P_{em}} = \chi^4 Q_{em} Q_{det} \frac{m_{\gamma'}^8}{\omega_0^8} |G|^2$



# ***-CASCADE Schematic***

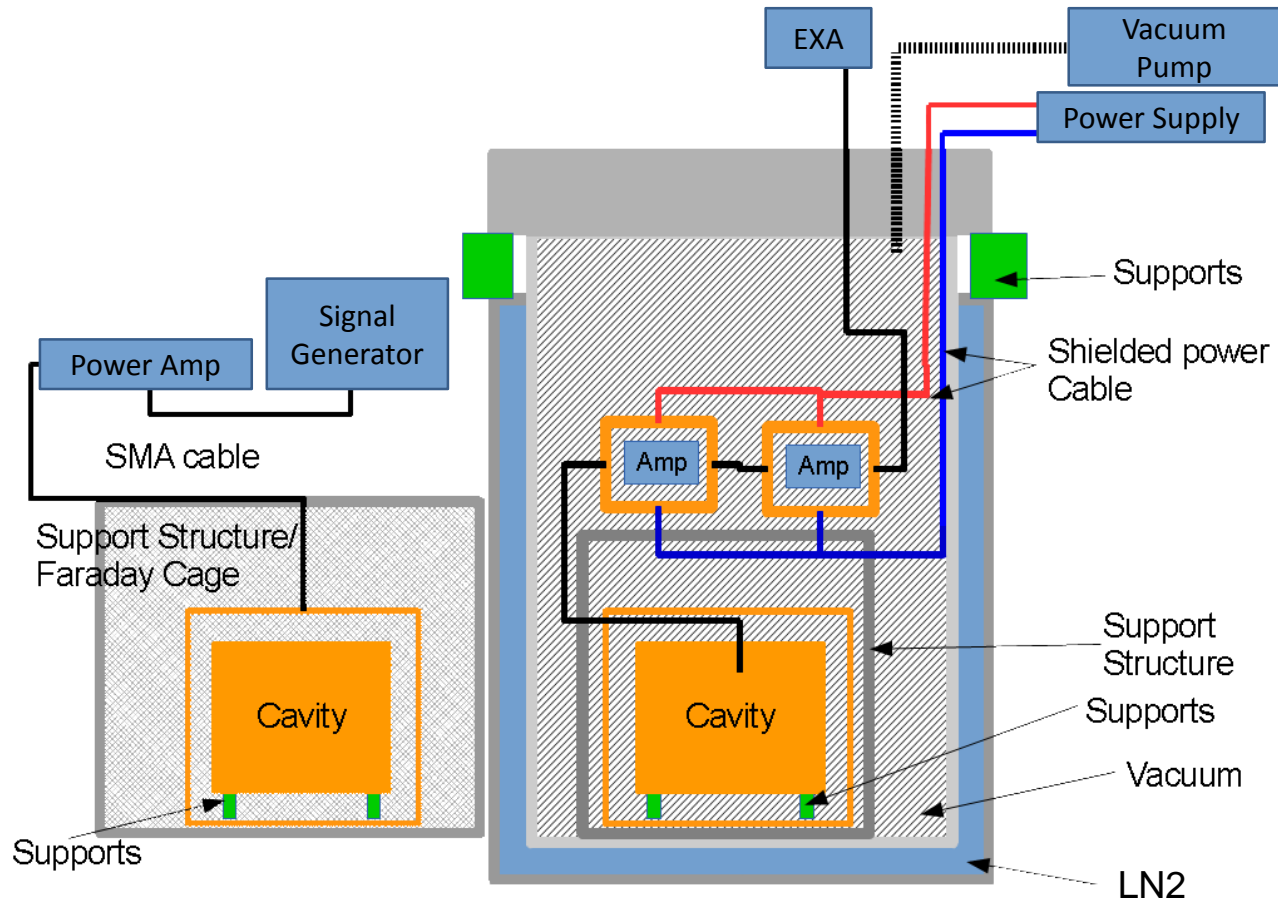

\*Not to scale

# CASCADE Measurements Using Pillbox Cavities

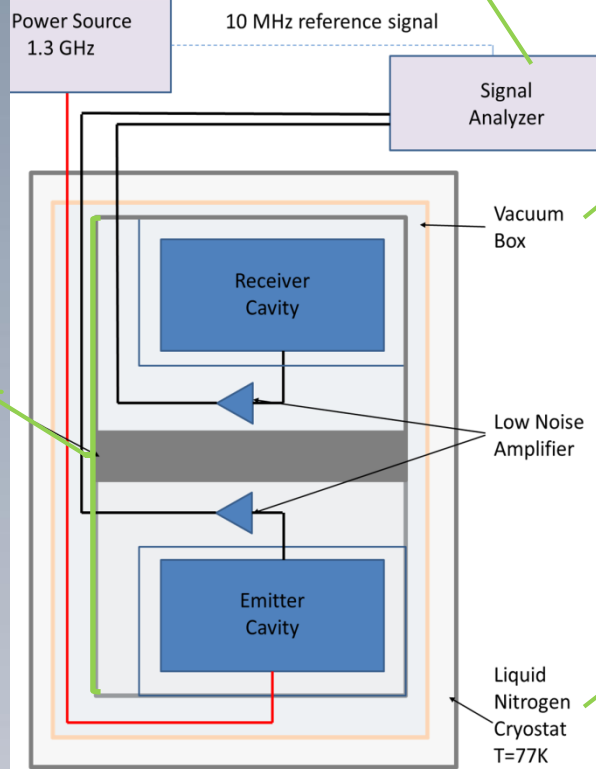
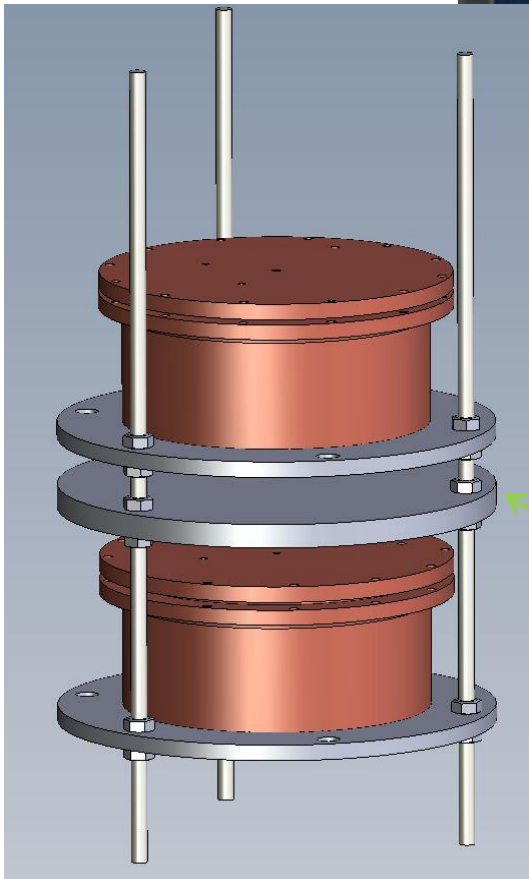
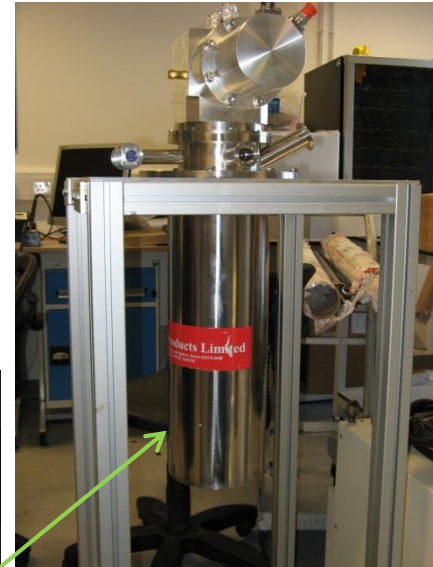
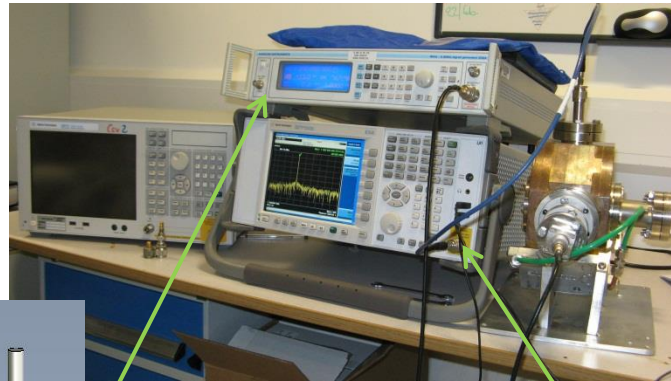

Adapted from: F. Caspers et al., *CERN-BE-Note-2009-026*

# -First Results

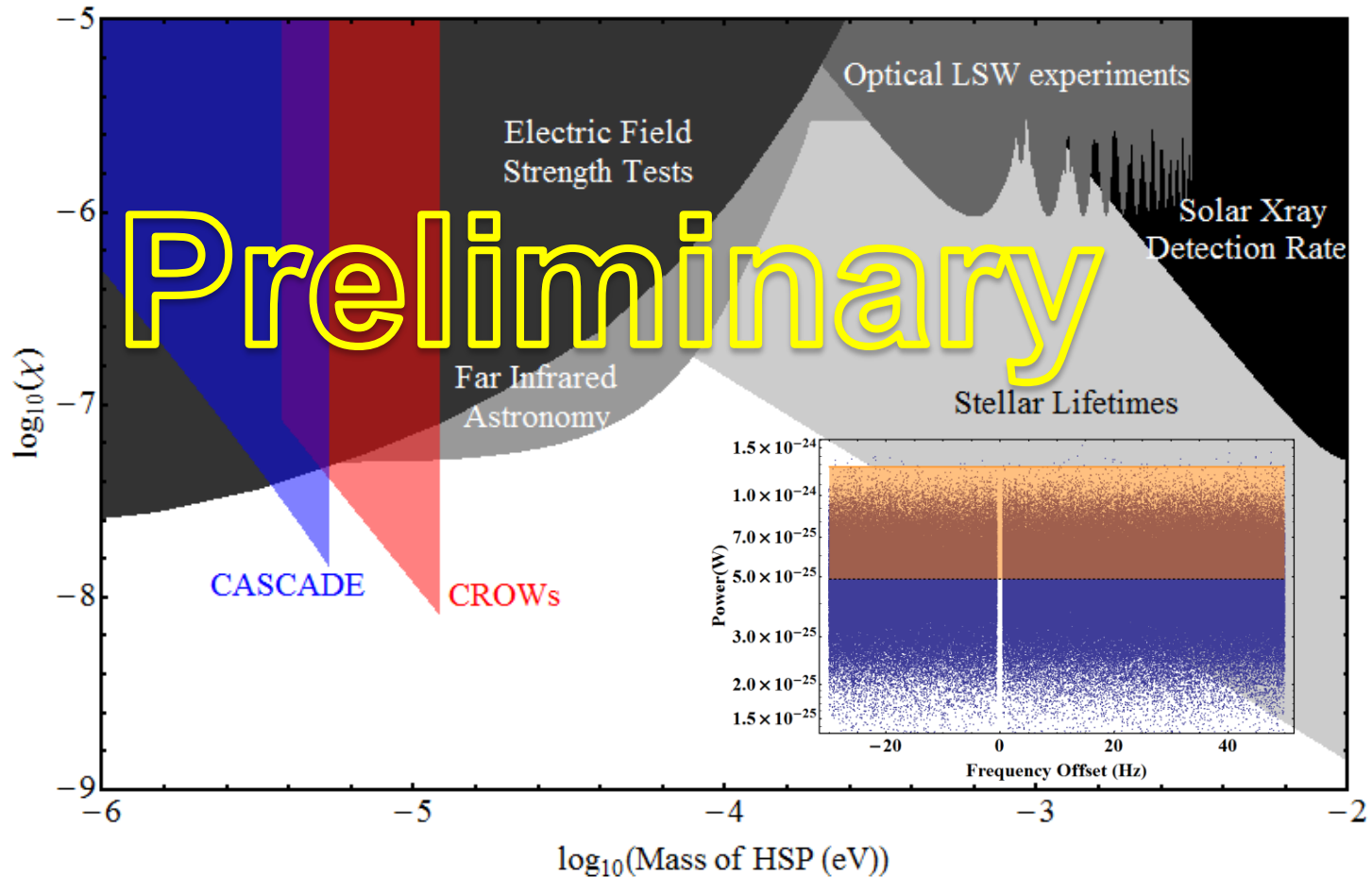

# CASCADE Measurements Using Superconducting Cavities

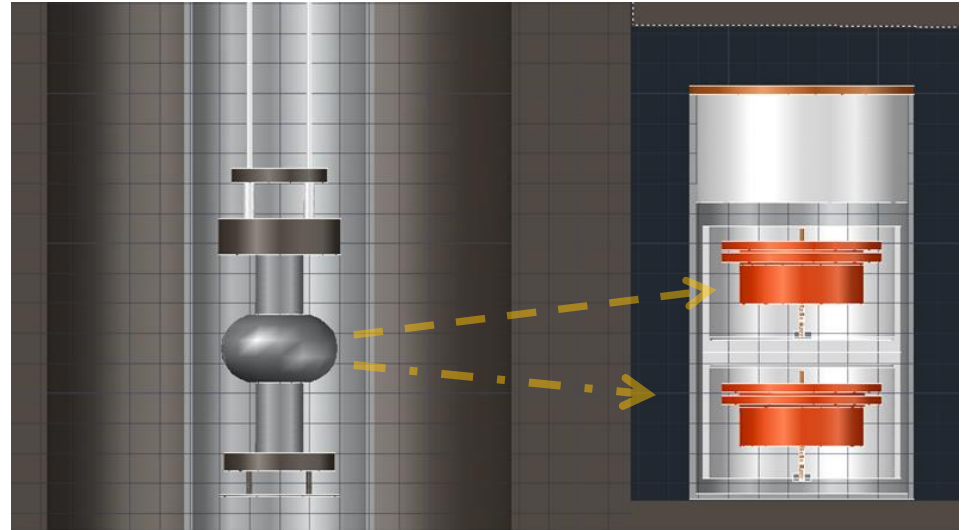

- To increase input power and overall Q of the system, a superconducting cavity is used as an emitter
- Both copper cavities will be used as receivers to perform coincidence measurements
- The receiver cavities need to have at least 270 dB attenuating shielding between them and the emitter
- The double cavity setup will be placed in an underground tunnel next to the Vertical Test Facility (VTF) at the Daresbury Laboratory
- The measurements can be made parasitic to standard cavity testing in the VTF



# Possible Exclusion

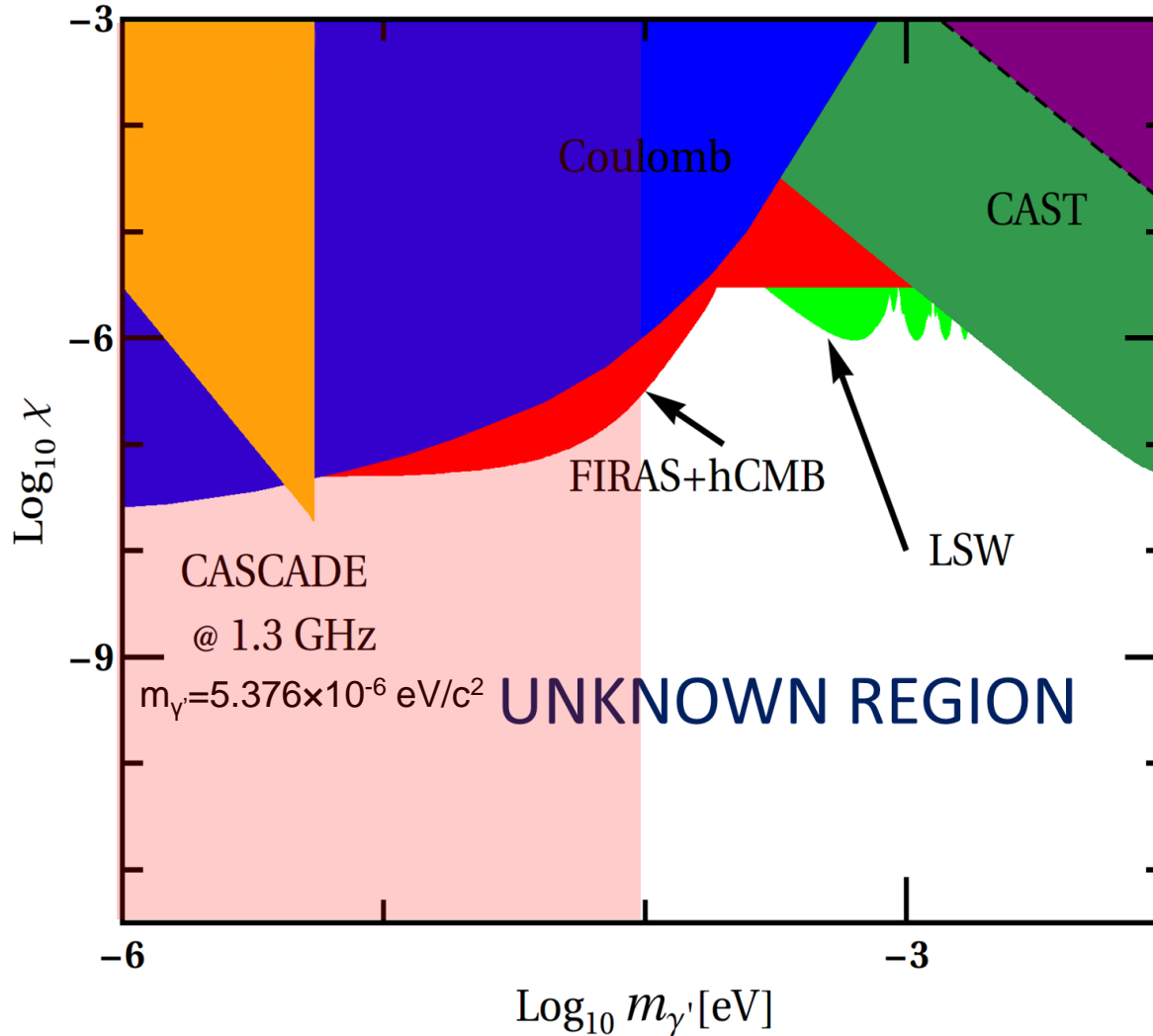

*"Nothing happens unless first a dream!"*

**-- American poet Carl Sandburg**

*"The task of the mind is to create the future!"*

**-- French poet Paul Valery**

*"The future belongs to those who believe in the beauty of their dreams."*

**-- Eleanor Roosevelt**

