



First Results for the ILC Polarization from Realistic Undulator

Khaled Alharbi and Dr. Ayash Alrashdi
1st year PhD student at Hamburg University, DESY.

POSIPOL Workshop 14-16 September 2016, LAL
University Paris-Sud .

- ❖ Holding a Master degree in Nuclear Science and Technology, Manchester University.

- ❖ Working at the National Center for Accelerator Technology at KACST, Saudi Arabia.

- ❖ Started doing PHD research on July 2016 at Hamburg University and DESY

- ❖ **Supervised by:**

- ❖ Prof. Gudrid Moortgat-Pick, Hamburg, DESY.
- ❖ Dr. Sabine Riemann, DESY.
- ❖ Dr. Ayash Alrashdi, KACST.

OUTLINE

- ❖ Introduction
- ❖ HUSR/GSR Software Spectra
- ❖ Energy spectrum from ideal and realistic Undulator field maps
- ❖ Ideal Undulator (Spectra & Polarization)
- ❖ Prototype helical undulator module
- ❖ Realistic Undulator (Spectra & Polarization)
- ❖ Comparing Results (Ideal & Realistic undulator)
- ❖ Conclusion

INTRODUCTION

- 10^{16} photon/s Required for high-luminosity electron positron colliders such as the ILC.
- The RDR parameters for the baseline positron source at 150 GeV are assumed throughout this talk.

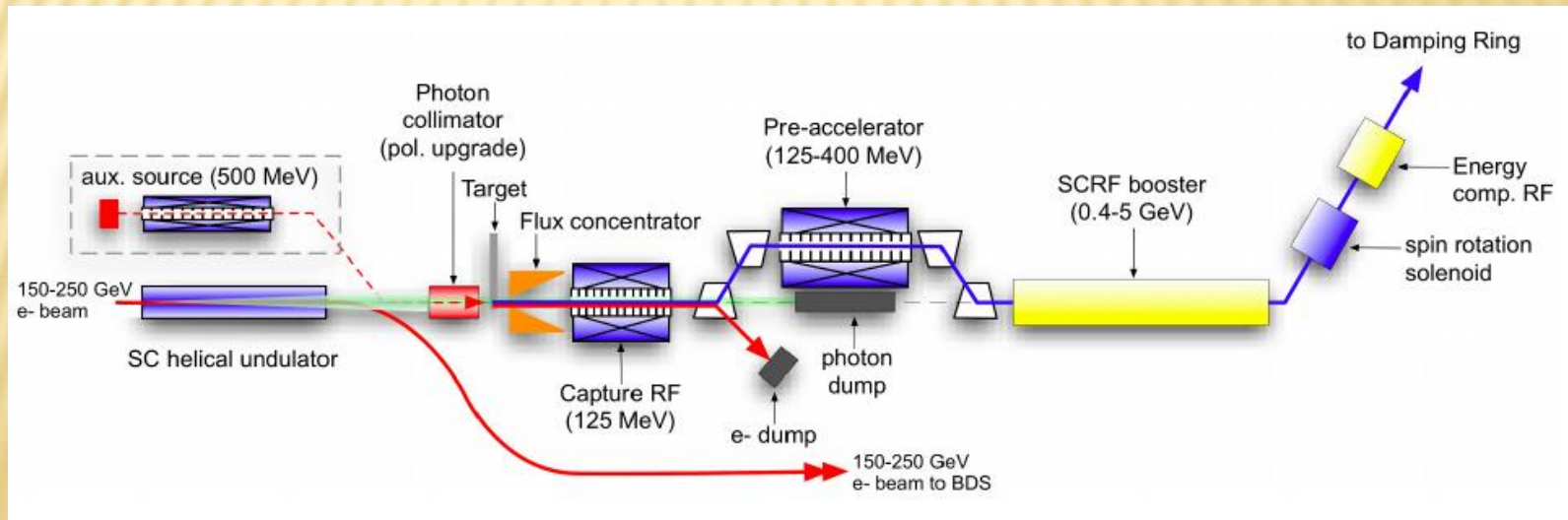

PARAMETERS USED

An electron travels through the undulator on a helical trajectory around the central axis of undulator with these parameters

produce photons with energy about 10.5 MeV

Parameters	Values
Undulator period	11.5 mm
Number of Periods	155
Magnetic field	0.88 T
Value of K	0.92
Average energy of photon	10.5 MeV
Total length	147 m
Photon beam power	131 kW
Electron beam energy	150 GeV

From previous talk in POSIPOL 2015
presented by Dr. Ayash Alrashdi

HUSR/GSR SOFTWARE SPECTRA

- Can simulate photon spectra produced by Undulator
- Developed at Cockcroft Institute by David Newton.
- How HUSR work? Interplot Magnetic data **then** Fourier transformed **at the end** photon spectra
- HUSR/GSR simulates a photon spectrum from an arbitrary magnetic field map.
- Using different arbitrary maps is possible in HUSR e.g. include errors in the magnet, tapering, etc.
- Some HUSR advantages? Speed of the calculation and can be extended to more functionality as it is a C++ code

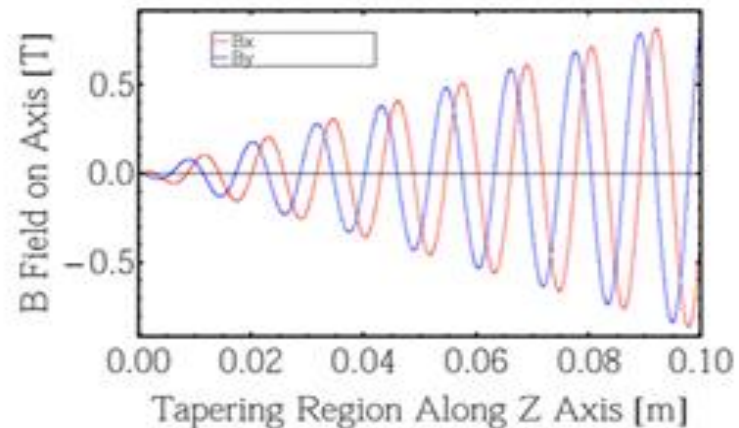
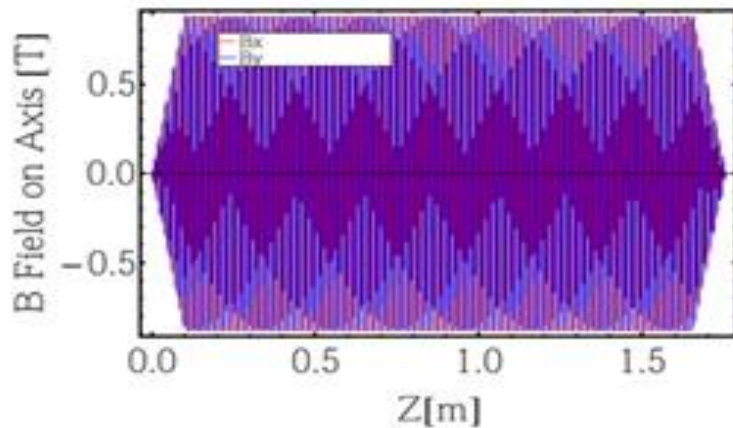

Bench marking HUSR/GSR energy spectra with Kincaid energy spectra.

The photon energy spectrum generated by 150 GeV electron by Kincaid Equation in red, and HUSR in blue.

They **agree** as we see

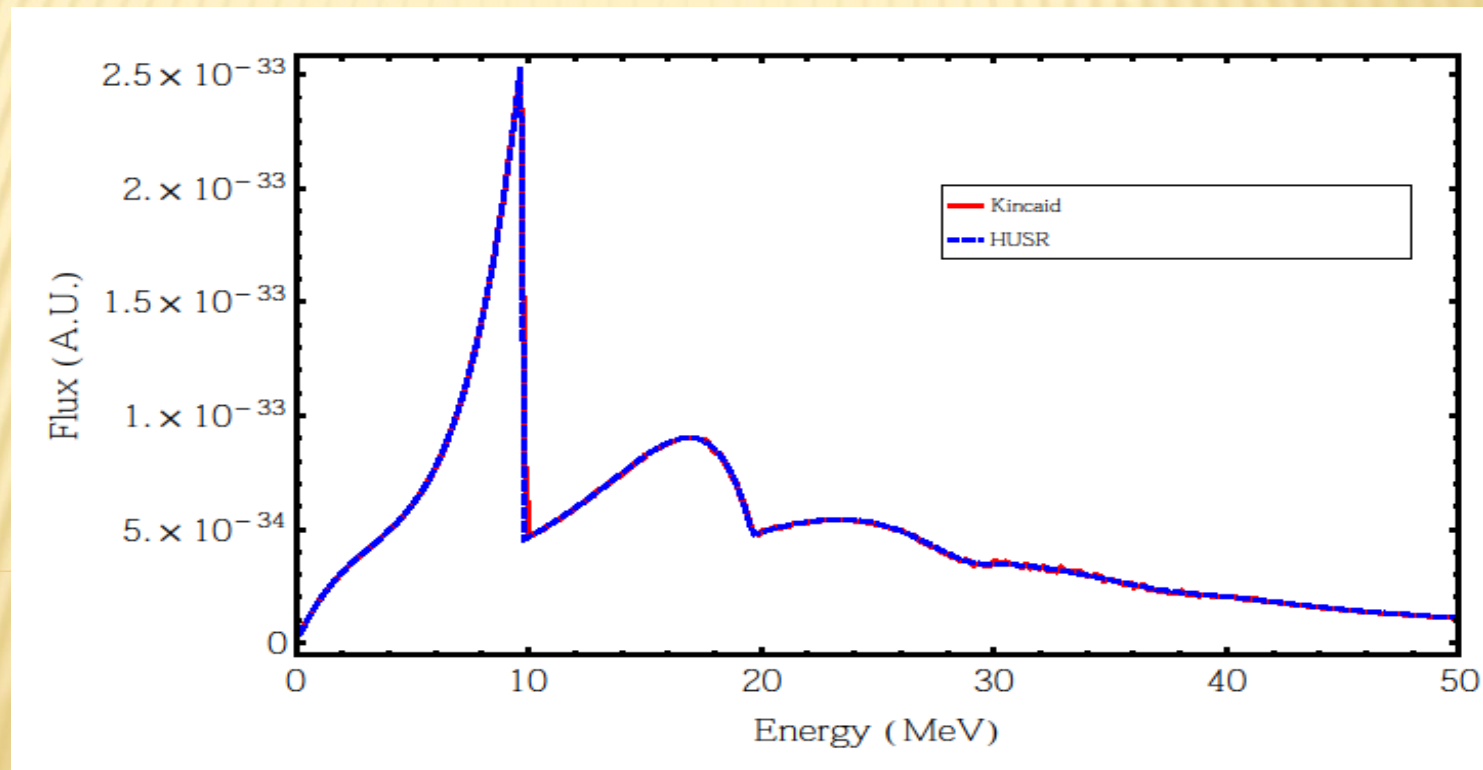

*Now I am using the results from HUSR
software to investigate the effect of using the
realistic field map on the polarization.....*

SPECTRUM FROM THE IDEAL UNDULATOR

Using the parameters from previous table

Number of photons: left handed in **red**, and right handed in **blue**,
the total in **Black**

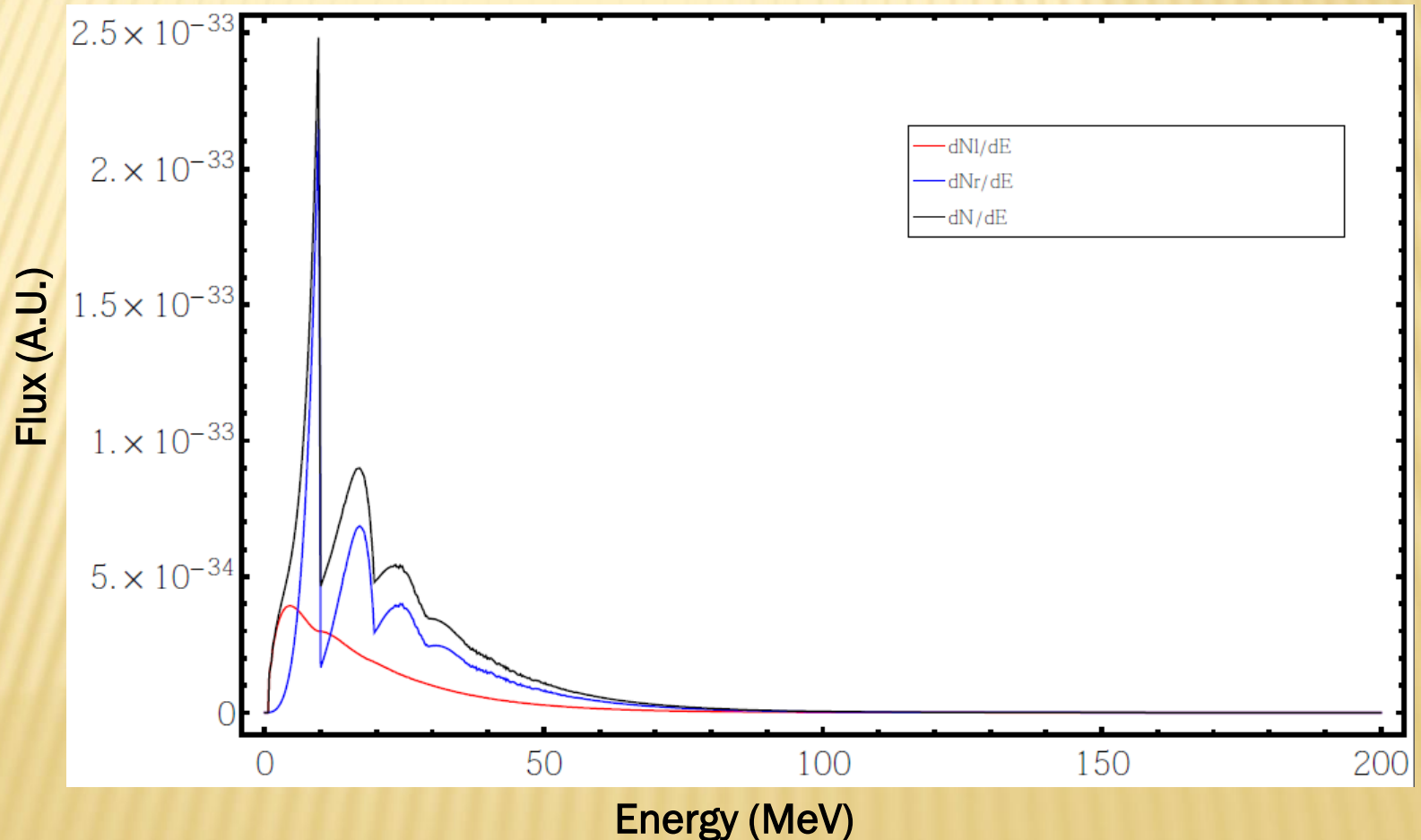

POLARIZATION FROM THE IDEAL UNDULATOR

Photon Polarization, P , calculated by
$$P = \frac{Nl - Nr}{Nl + Nr}$$

Where Nl is number of left handed photons, Nr is the right handed photons

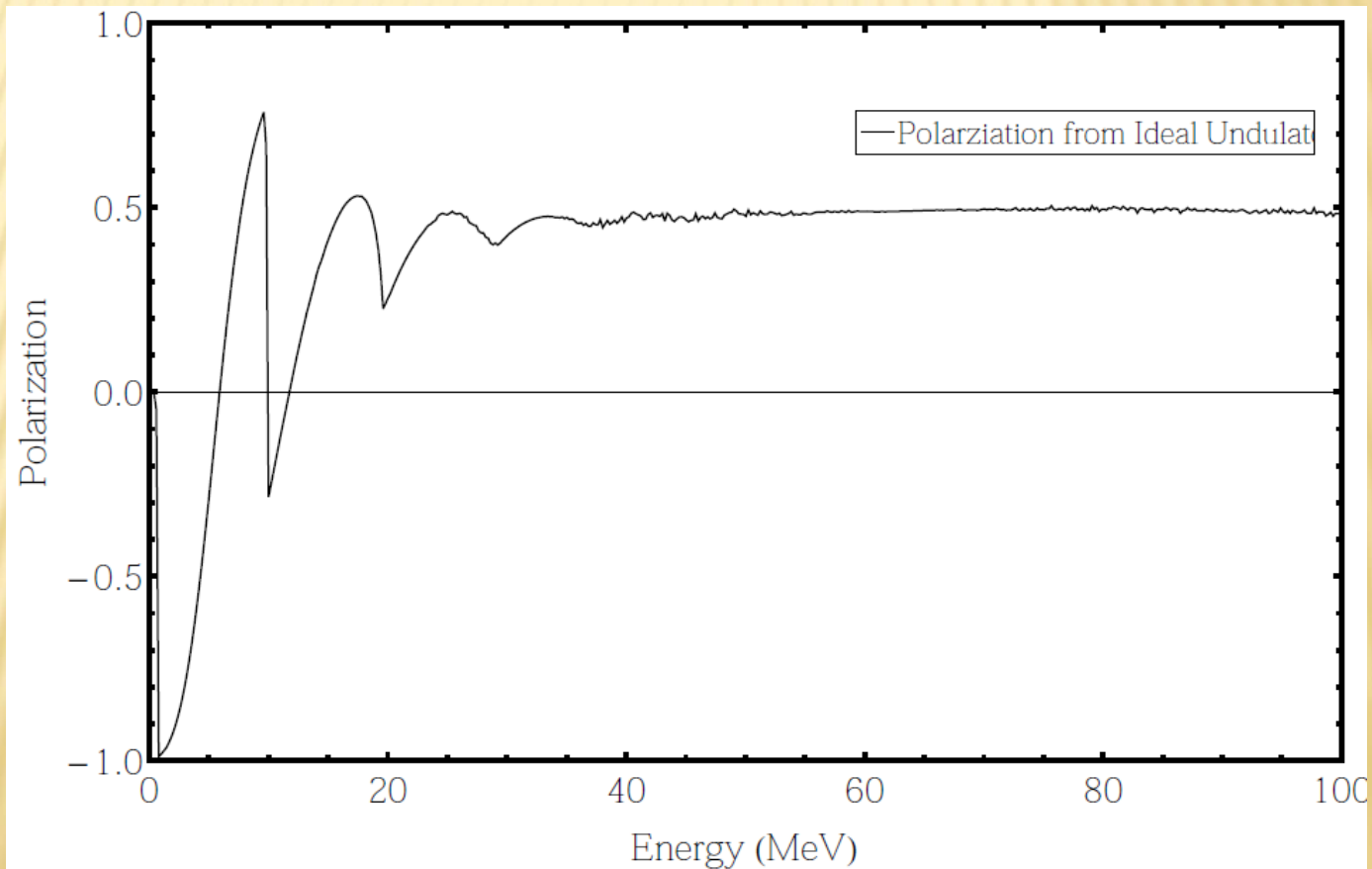

PROTOTYPE HELICAL UNDULATOR MODULE

Built by a team from Rutherford Appleton and Daresbury Lab
The 4m long contains two helical undulator in series each 1.75m
This undulator was simulated by HUSR using the major magnetic field map & parameters

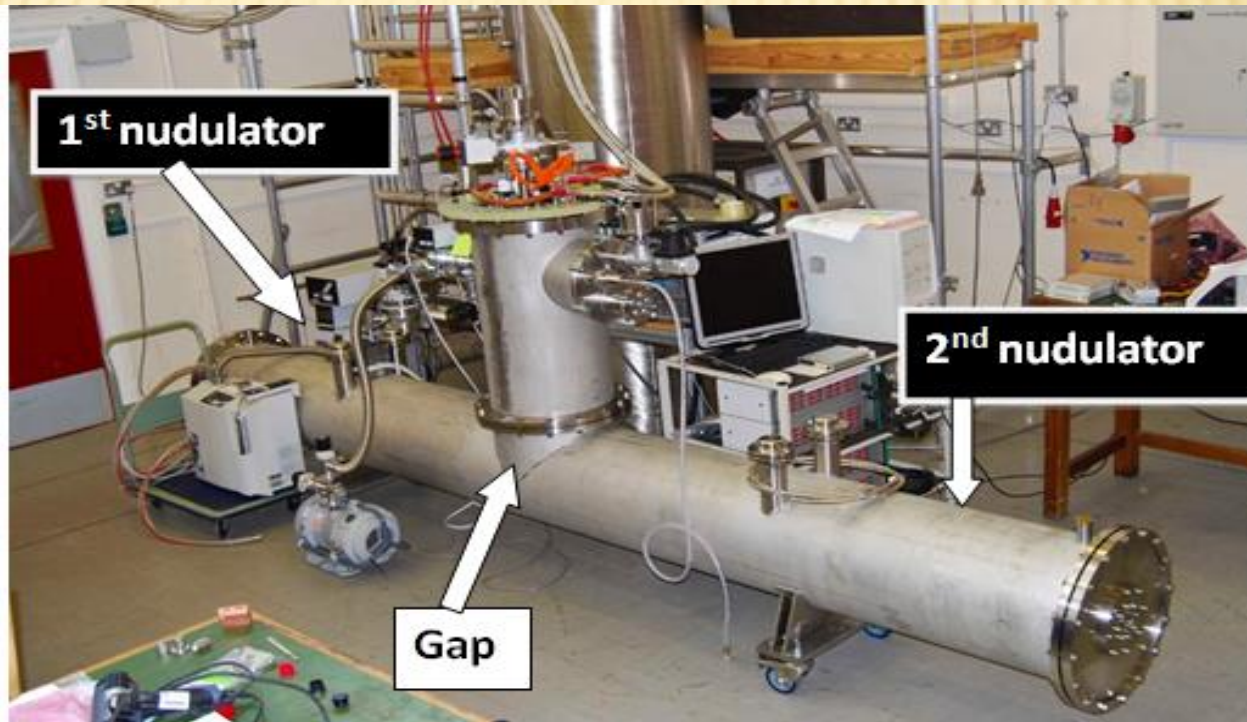

SPECTRUM FROM THE 1ST REALISTIC UNDULATOR

Number of photons: left handed in **red**, and right handed in **blue**,
the total in **Black**

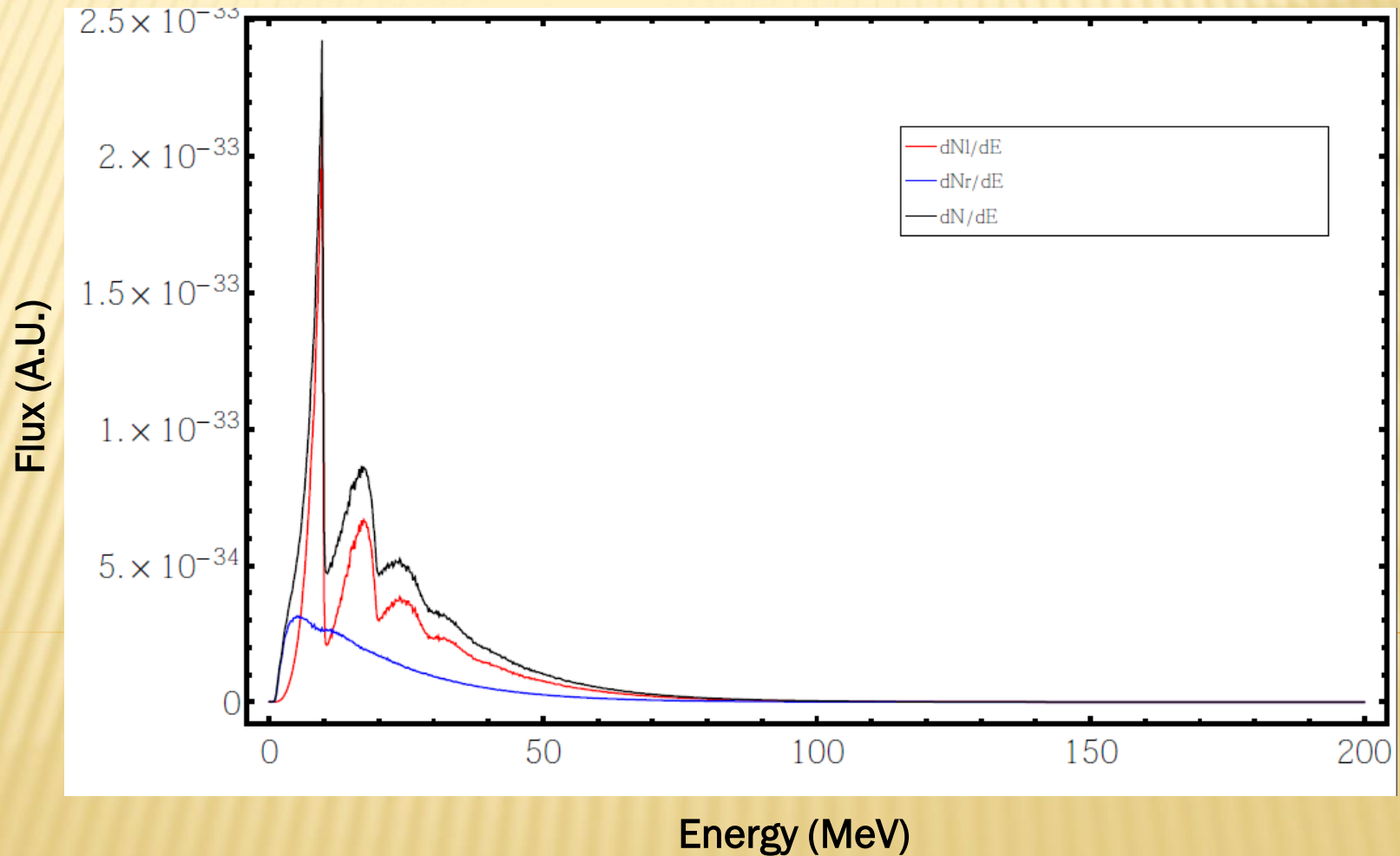

POLARIZATION FROM THE 1ST REALISTIC UNDULATOR

Photon Polarization, P , calculated by
$$P = \frac{N_l - N_r}{N_l + N_r}$$

Where N_l is number of left handed photons, N_r is the right handed photons

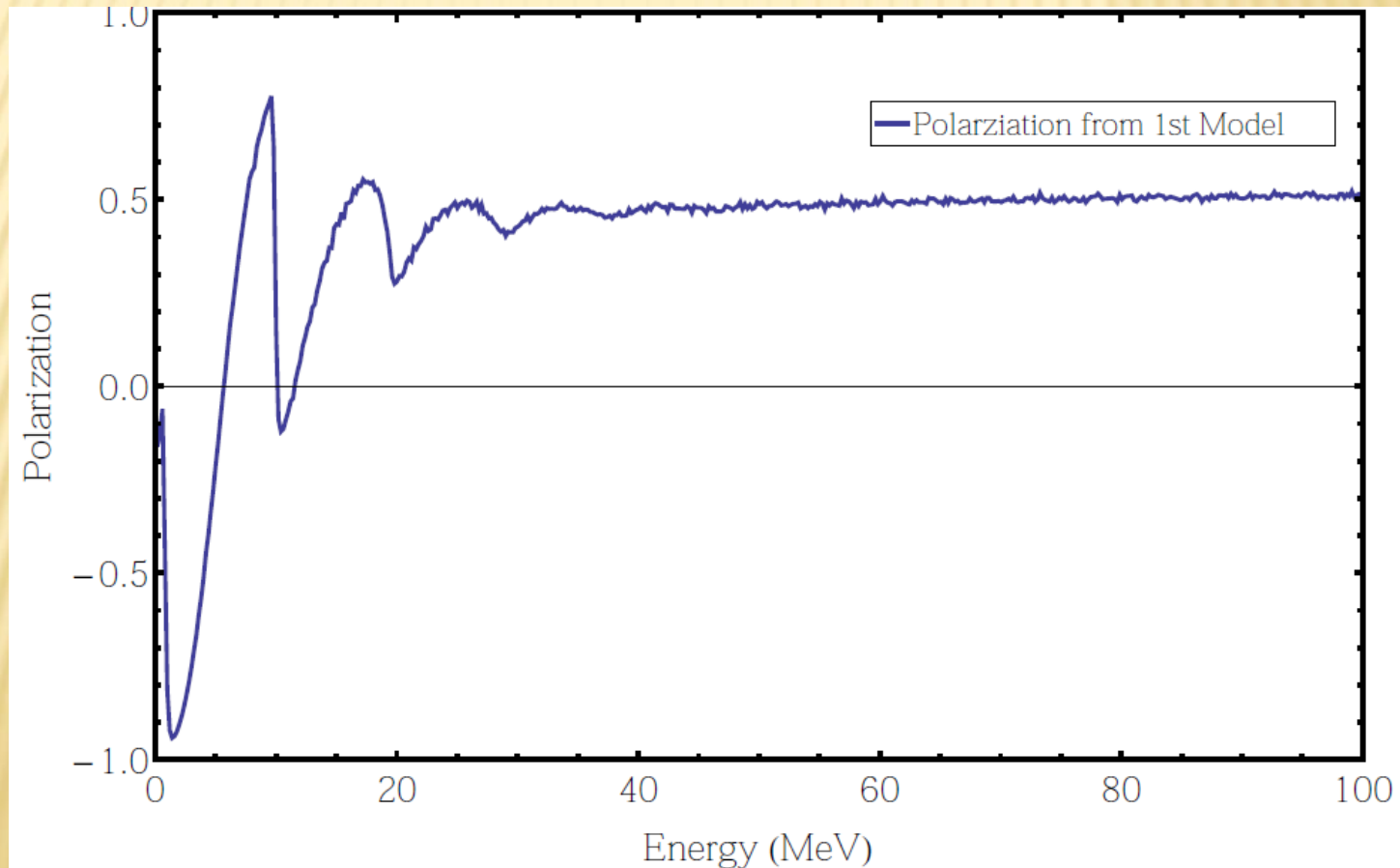

SPECTRUM FROM THE 2ND REALISTIC UNDULATOR

Number of photons: left handed in **red**, and right handed in **blue**,
the total in **Black**

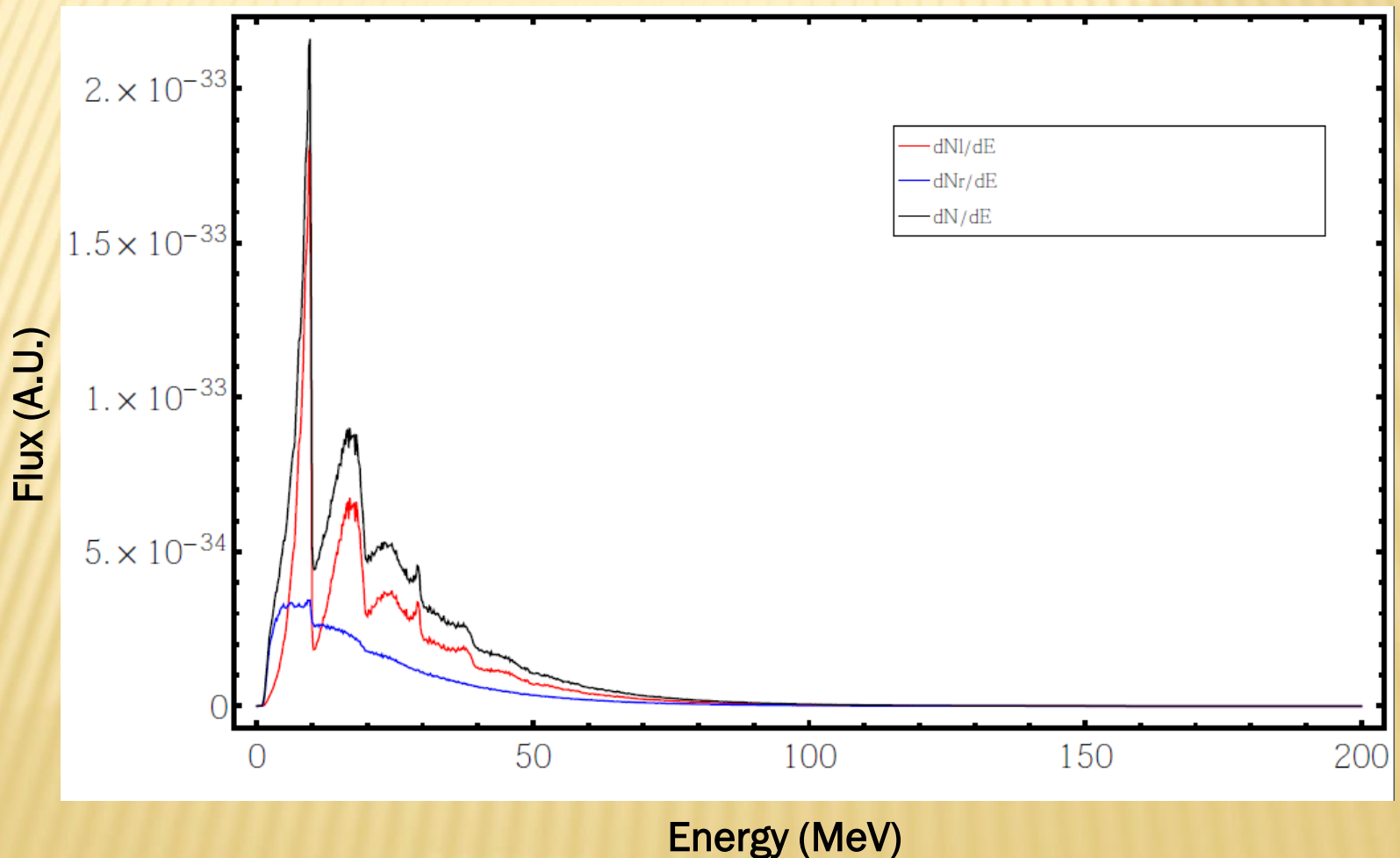

POLARIZATION FROM THE 2ND REALISTIC UNDULATOR

Photon Polarization, P , calculated by

$$P = \frac{Nl - Nr}{Nl + Nr}$$

Where Nl is number of left handed photons, Nr is the right handed photons

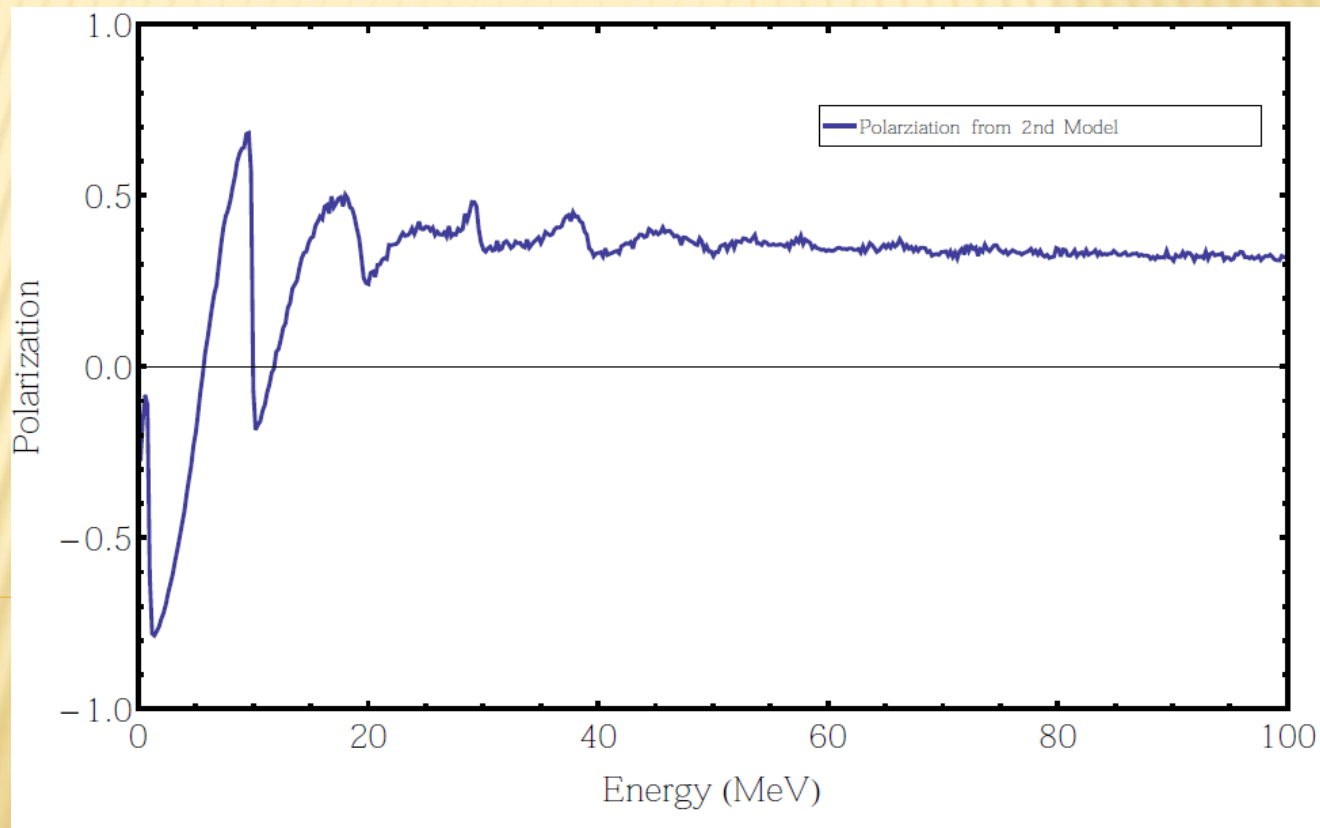

COMPARING BETWEEN POLARIZATION FROM 1ST & 2ND MODULE OF REALISTIC UNDULATOR

- Polarization from 1st undulator is higher than that from 2nd undulator
- The errors are high in 2nd one

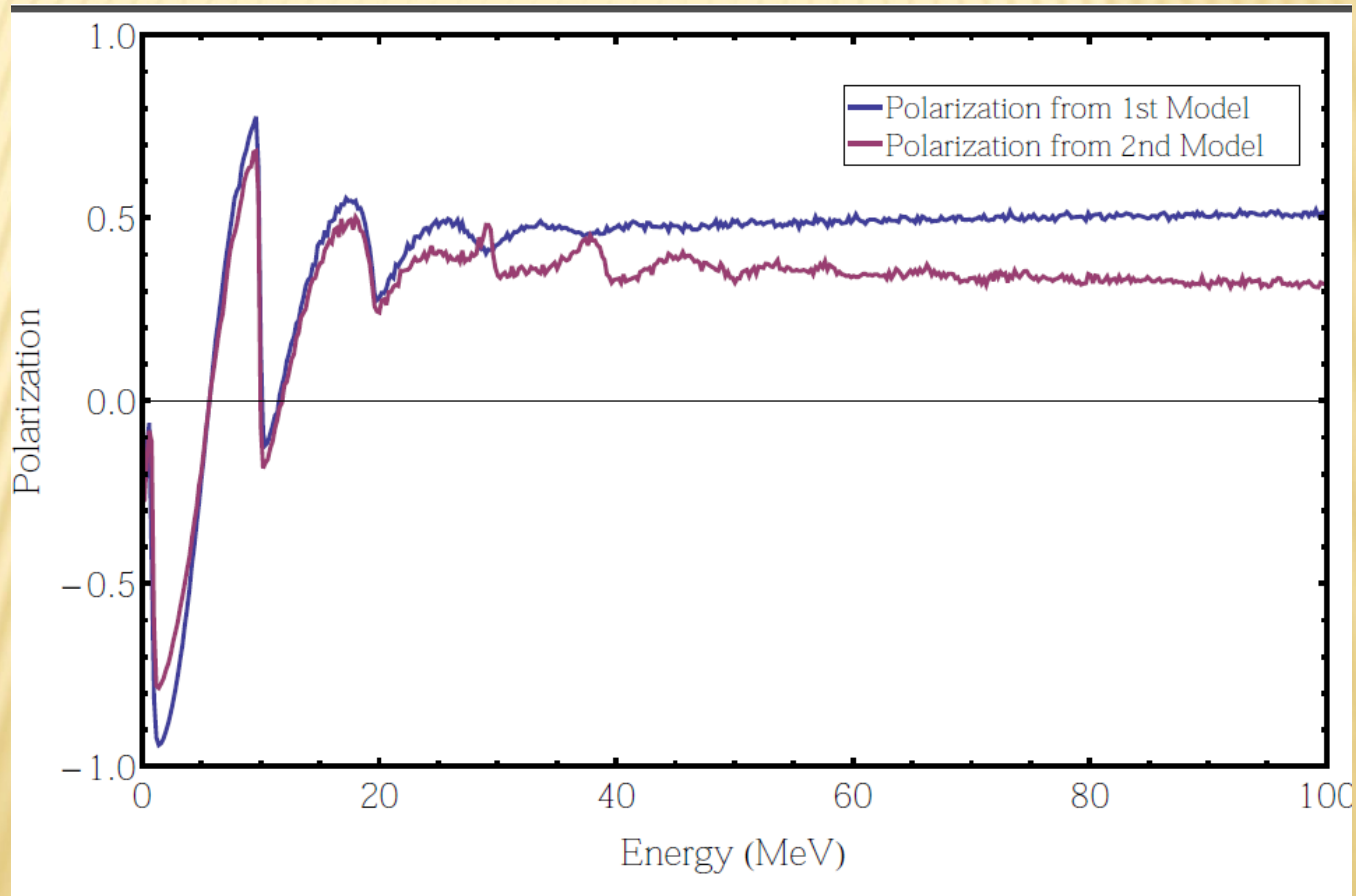

COMPARING BETWEEN POLARIZATION FROM THE REALISTIC AND IDEAL UNDULATOR

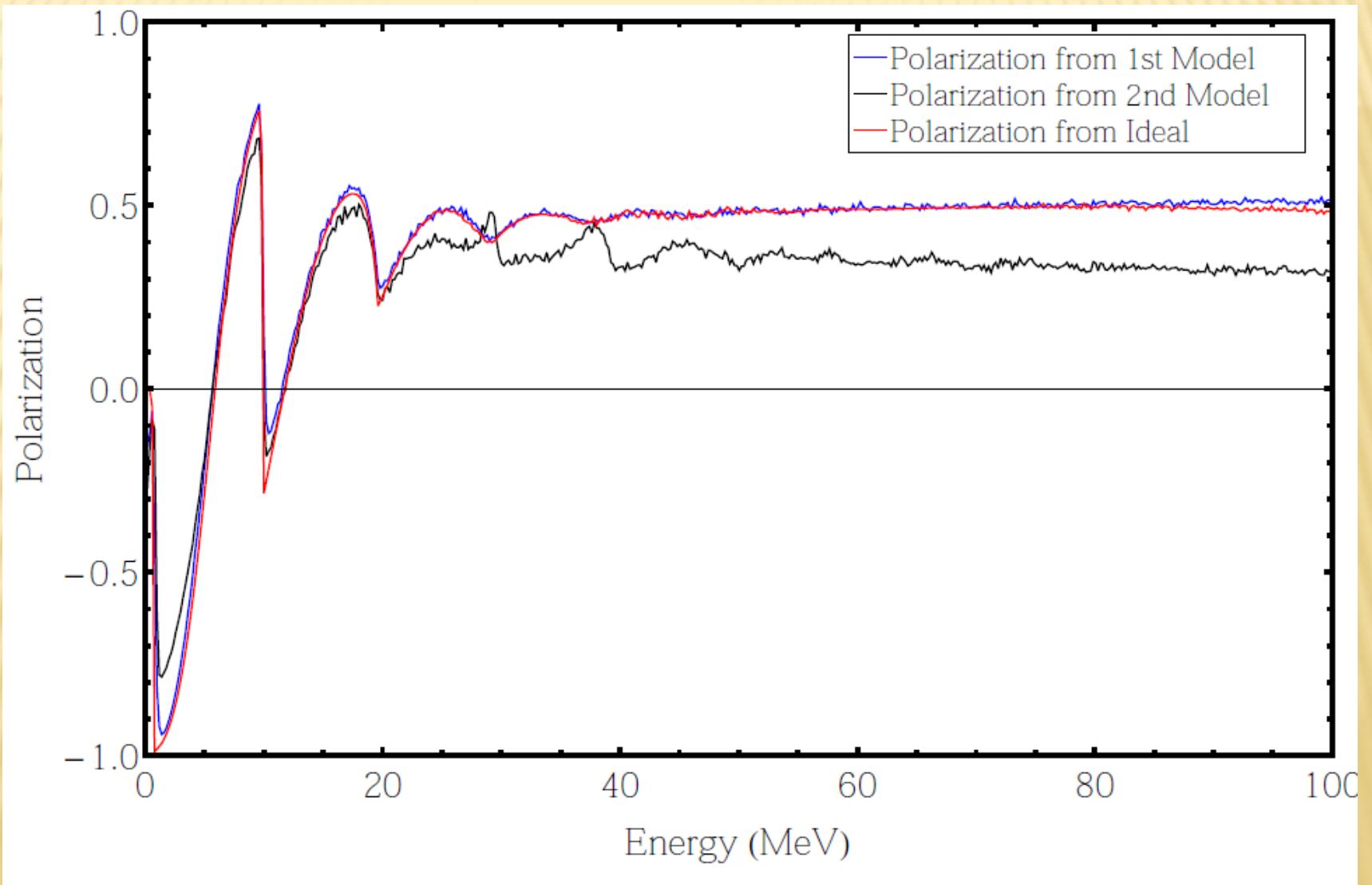

CONCLUSION

- We've seen the good **agreement** between the **HUSR** energy spectra & **Kincaid** energy spectra.
- HUSR is **brilliant** to simulate the photon spectra produced by Undulator
- The **prototype helical undulator** was simulated by HUSR and polarization from 1st undulator & Ideal undulator agreed while from the 2nd decreased

FUTURE STEPS

- ✘ Different electron energies will be used like 250 GeV
- ✘ Different K values will be used as well
- ✘ Using PPS-SIM software to investigate the production of positrons from the realistic Undulator
- ✘ Polar Positrons that inherit the polarization of the photons will be studied
- ✘ Yield positrons for all these results will be Checked by PPS-SIM And so on

**Thank you for
your attentions**