



PERLE : A High Power Energy Recovery Facility at Orsay

On behalf of PERLE Collaboration

Walid Kaabi-LAL/CNRS



Storage Rings Vs. Linacs:

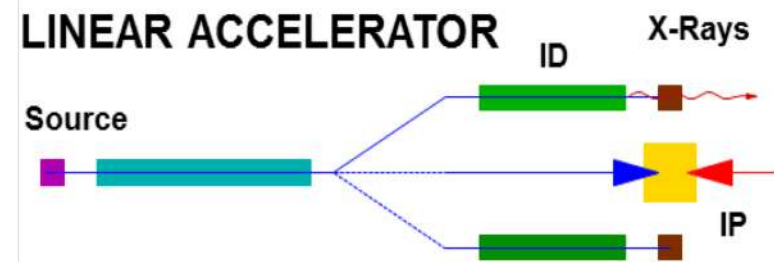
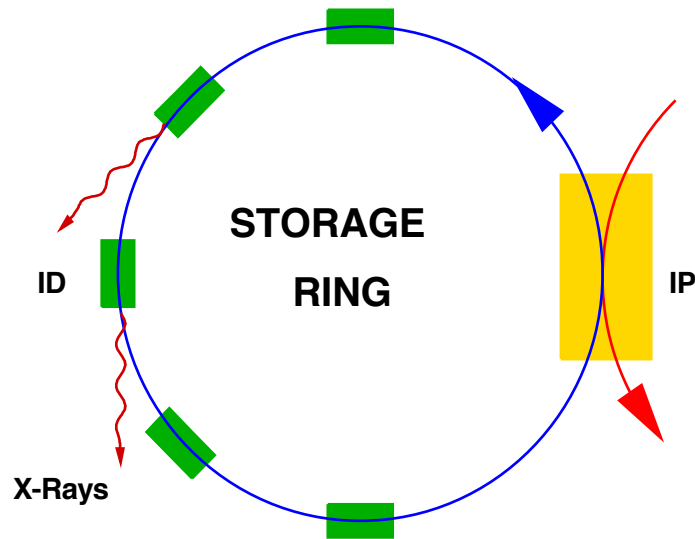

- beam parameters defined by equilibrium
- many user stations
- limited flexibility – multi-pass
- high average beam power (A, multi GeV)
- typically long bunches (20 ps – 200 ps)
- beam parameters defined by the source
- low number of user stations
- high flexibility – single pass
- limited average beam power (\ll mA)
- possible short bunches (sub psec)

ERLs: The Best of Both Worlds

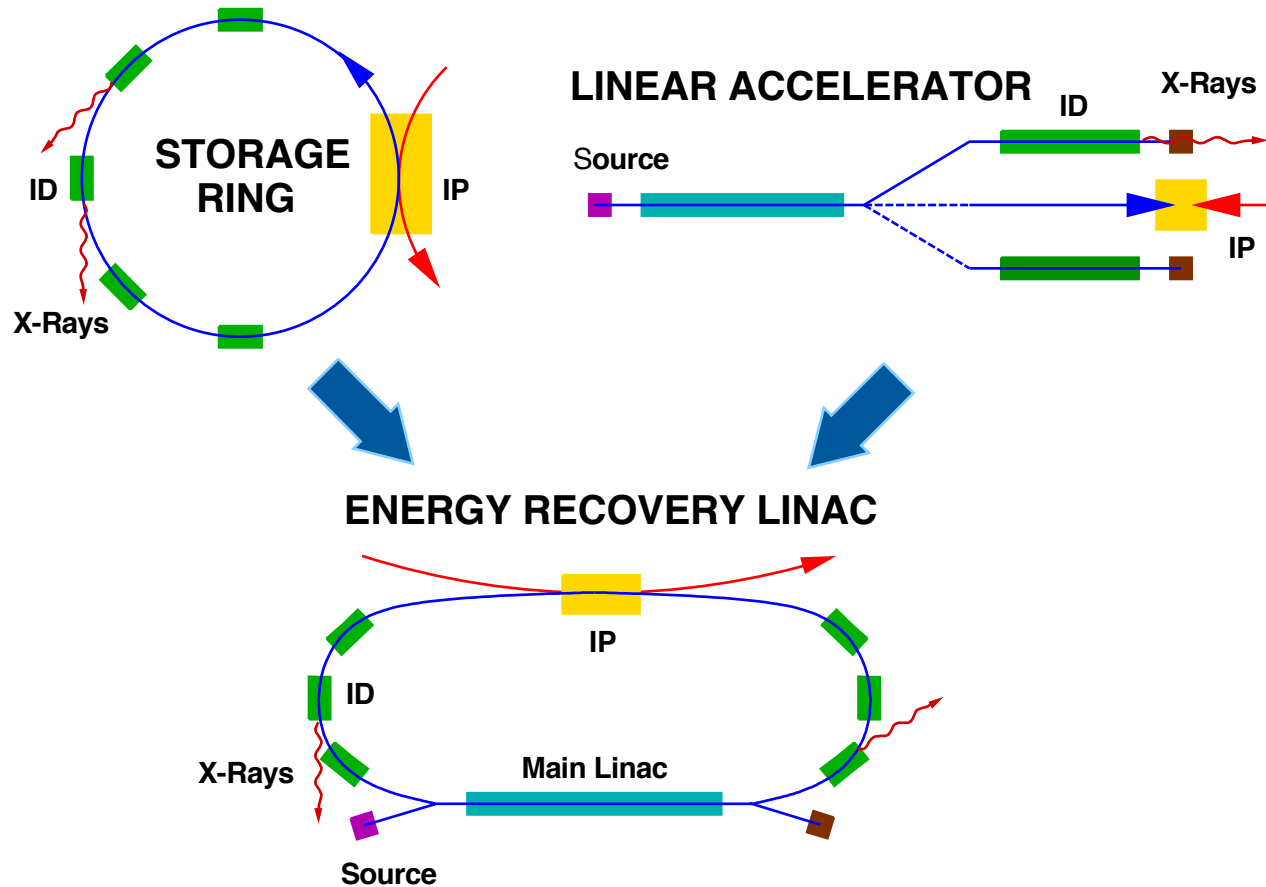

High average beam power (multi GeV @ some 100 mA) for single pass experiments, excellent beam parameters, high flexibility, multi user facility

ERLs: The Best of Both Words



- ERL concept was proposed first in 1965 by Maury Tigner ¹

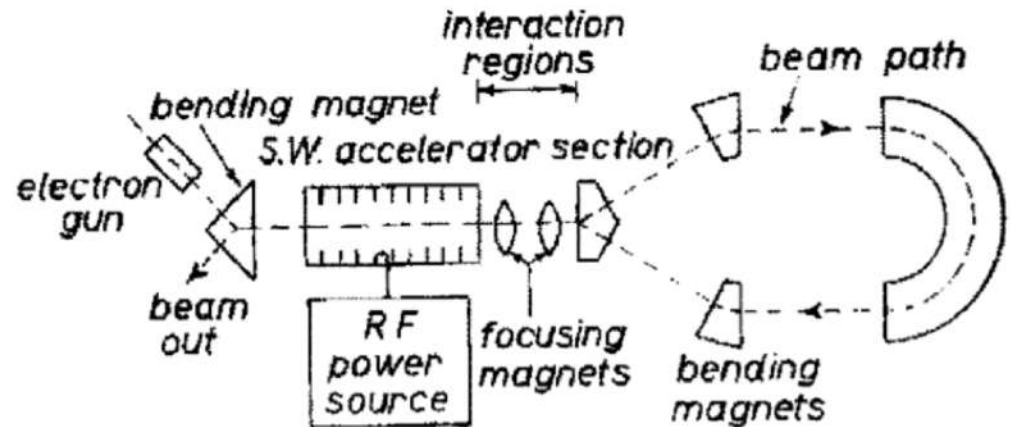
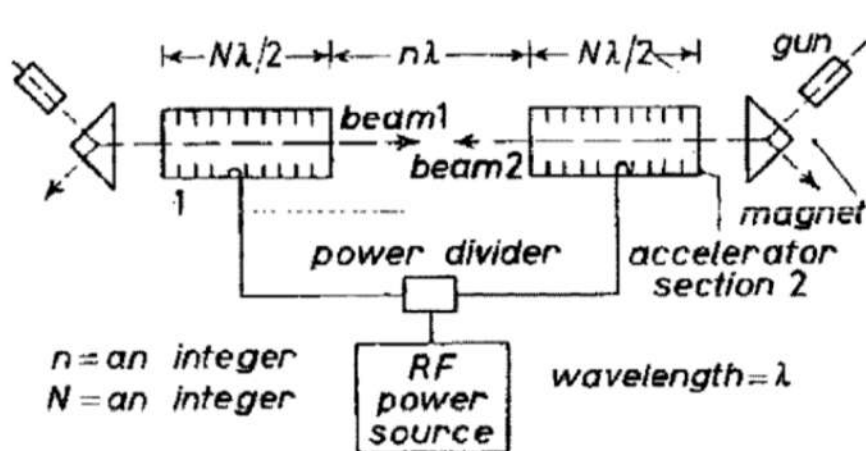

¹ M. Tigner: "A Possible Apparatus for Electron Clashing-Beam Experiments", Il Nuovo Cimento Series 10, Vol. 37, issue 3, pp 1228-1231, 1 Giugno 1965

- First test was done at SCA@ Stanford in 1986 (interesting concept for FELs, Compton light sources and high current electron cooler)
- Concept become only viable with recent advances in SRF technology.

Energy recovery in RF fields:

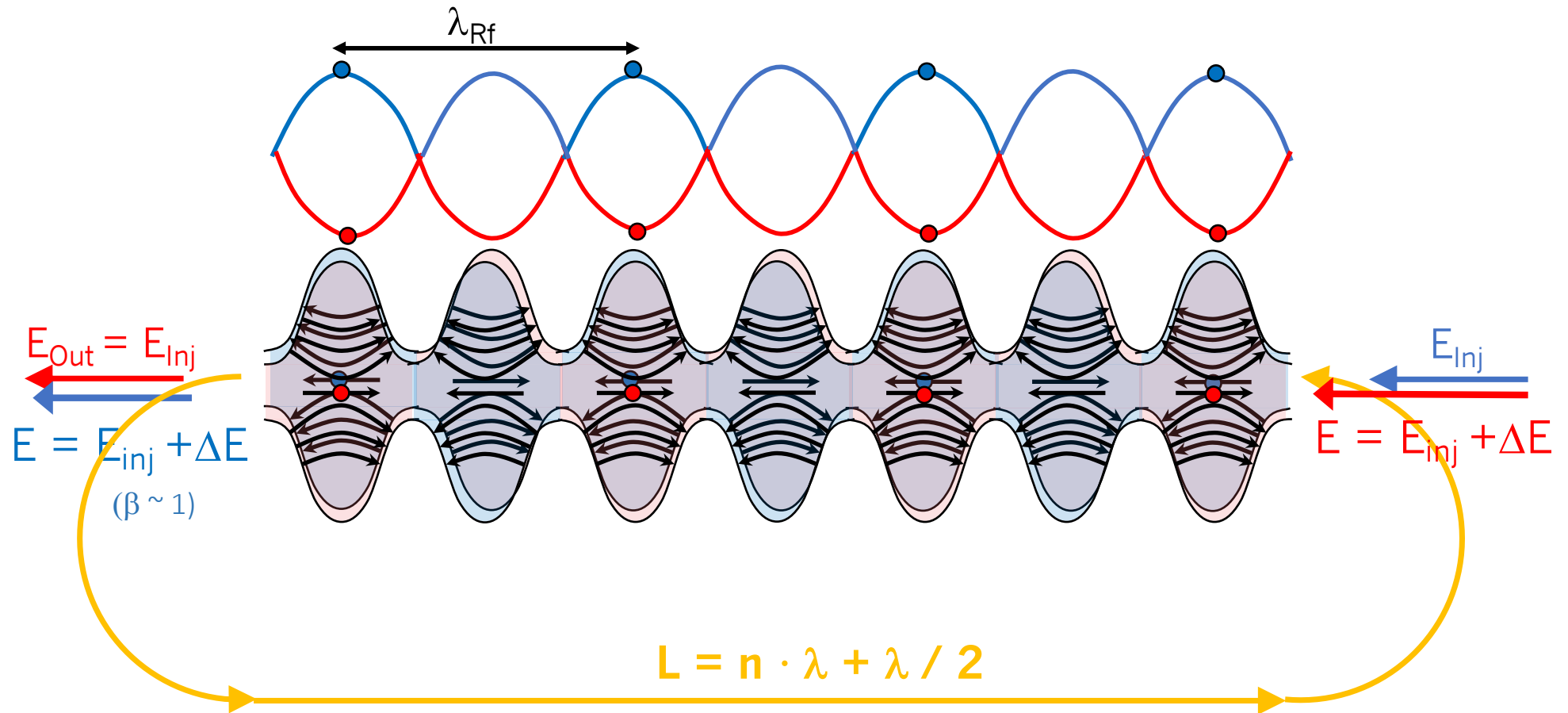

- Energy supply \rightarrow acceleration
- Deceleration = “loss free” energy storage (in the beam) \rightarrow Energy recovery

The Energy Recovery Linac Principle:

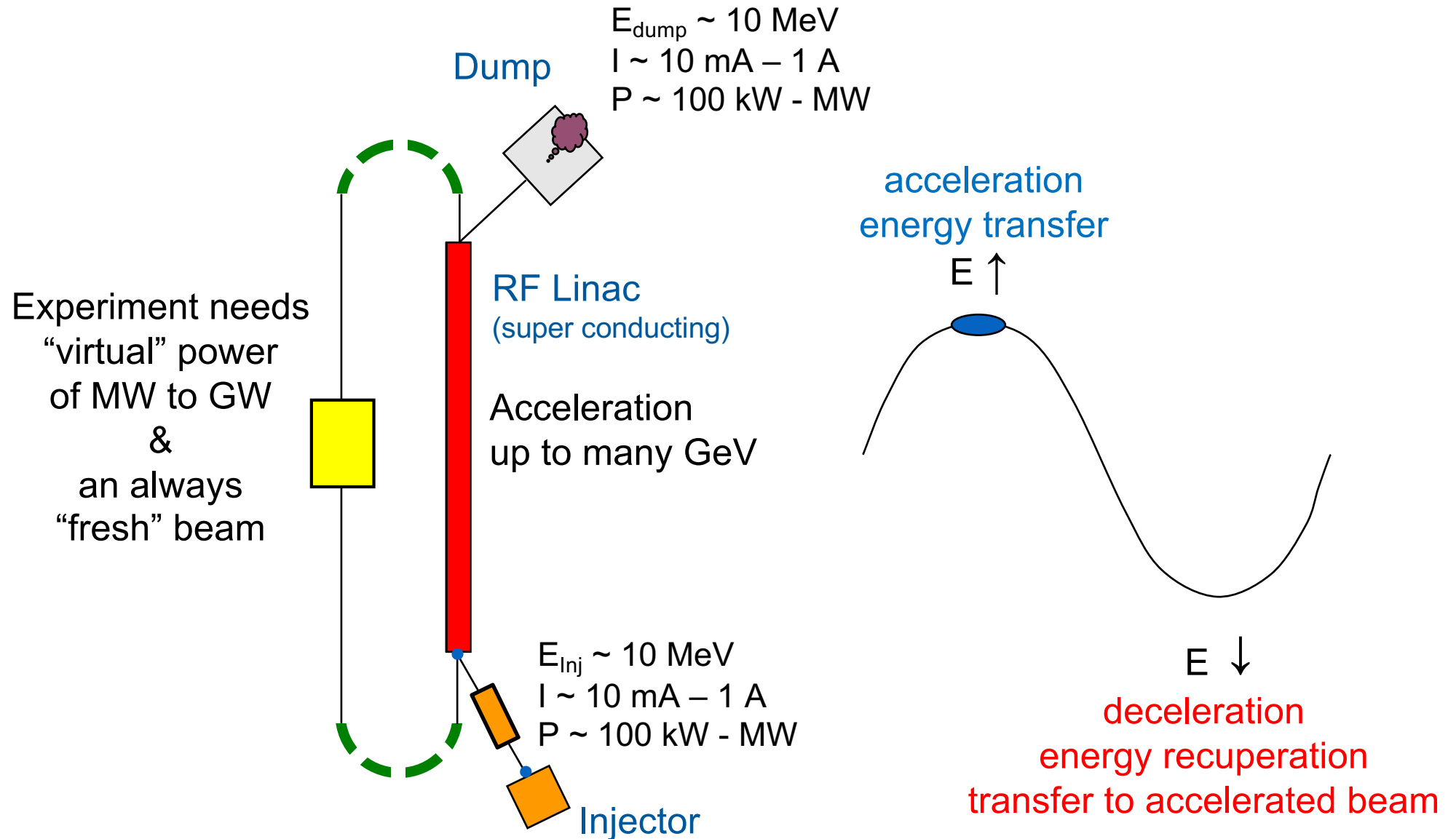

Introduction to PERLE:



PERLE: A proposed multiple pass ERL based on SRF technology, to serve as testbed for validating and testing a broad range of accelerator phenomena & technical choices for future projects.

Particularly, design challenges and beam parameters are chosen to enable PERLE as the hub for technology development (especially on SRF) for the Large Hadron Electron Collider (LHeC) [1]:

Target Parameter	Unit	Value
Injection energy	MeV	7
Electron beam energy	MeV	500
Normalised Emittance $\gamma\epsilon_{x,y}$	mm mrad	6
Average beam current	mA	20
Bunch charge	pC	500
Bunch length	mm	3
Bunch spacing	ns	25
RF frequency	MHz	801.58
Duty factor		CW

[1] J.L. Abelleira Fernandez et al, " A Large Hadron Electron Collider at CERN: Report on the Physics and Design Concepts for Machine and Detector ", J.Phys. G39 (2012) 075001, [arXiv:1206.2913](https://arxiv.org/abs/1206.2913)

PERLE in the global landscape:



Courtesy to C. Tennant- JLAB

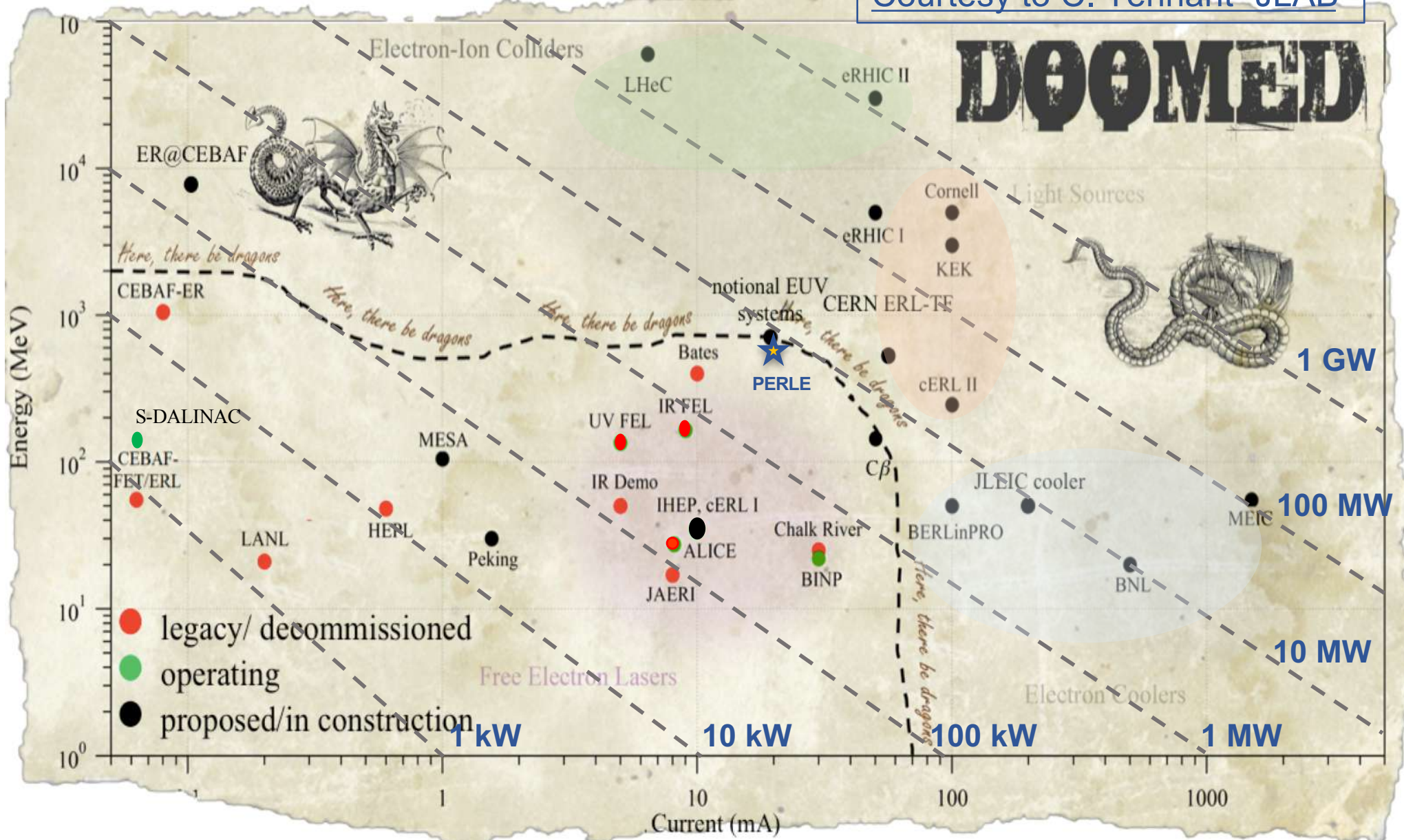

ERLs around the world:



Normal Conducting 180 MHz + DC Gun
30 mA, 11 MeV, 70-100 ps

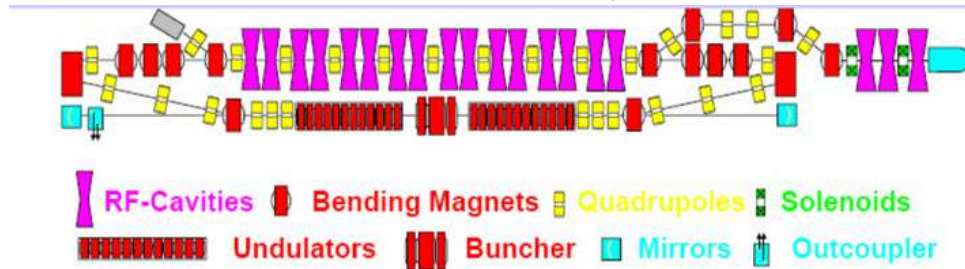

BINP, Novosibirsk

- 3-4 turn ERL
- Normal conducting RF

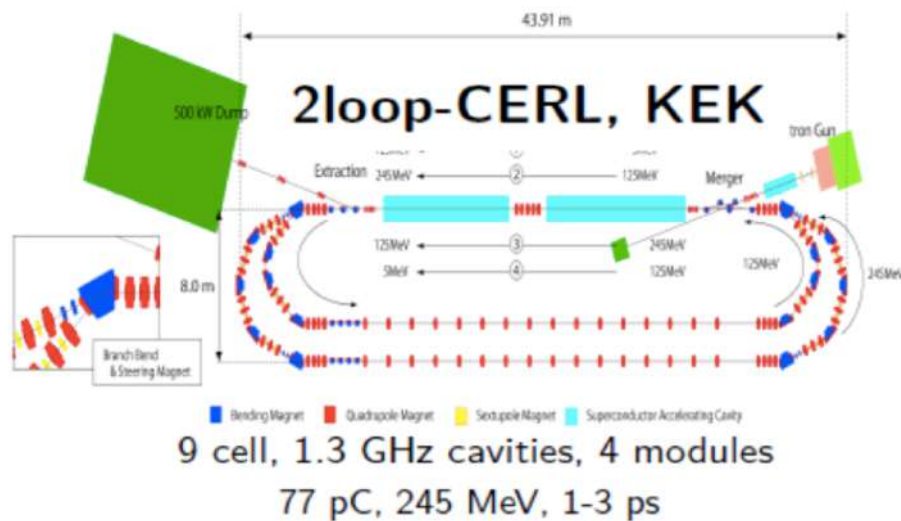
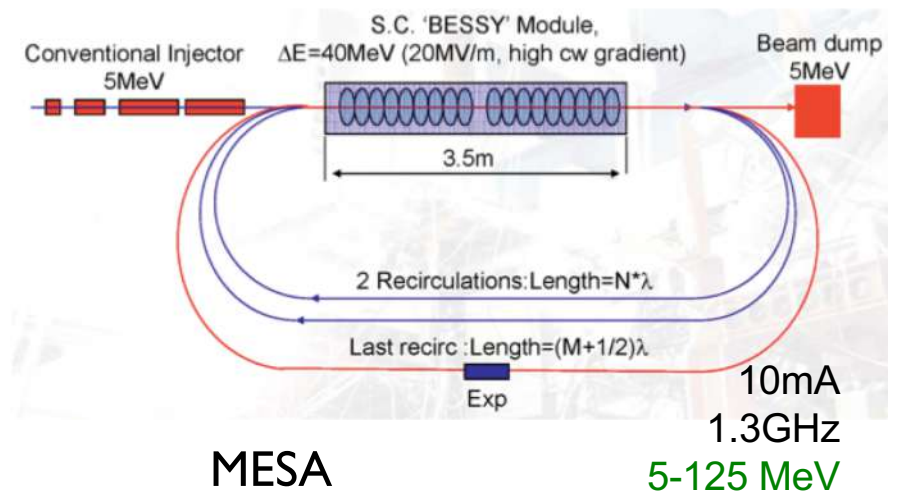

- At the moment only single loop operation
- Severe limitations in beam current due to injector

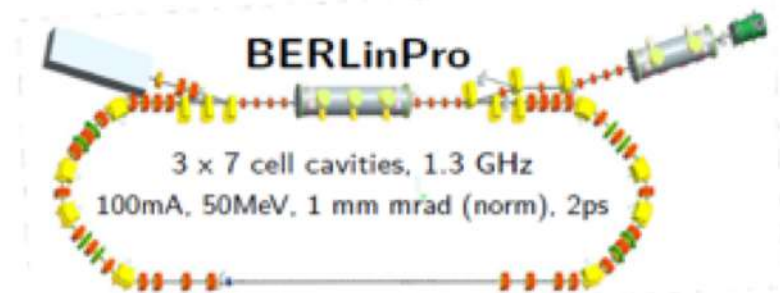

ERLs around the world:

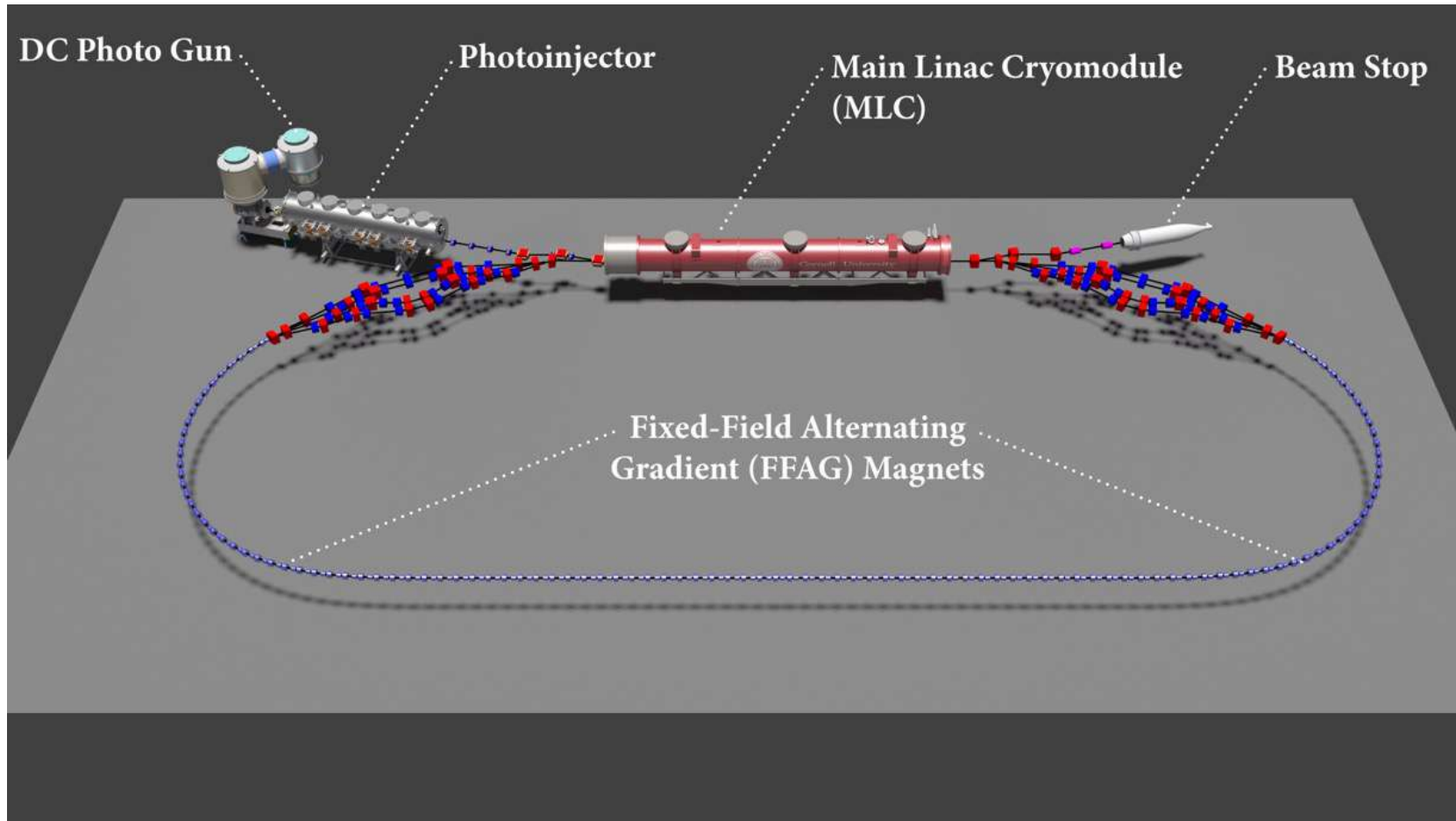

CBETA- Cornell (commissioning starts now: March 2019)
1.3 GHz, 4 turns, 40 mA, $E_{\max} = 150$ MeV

PERLE configuration:



- 2 Linacs (Four 5-Cell 801.58 MHz SC cavities)
- 3 turns (160 MeV/turn)
- Max. beam energy 500 MeV

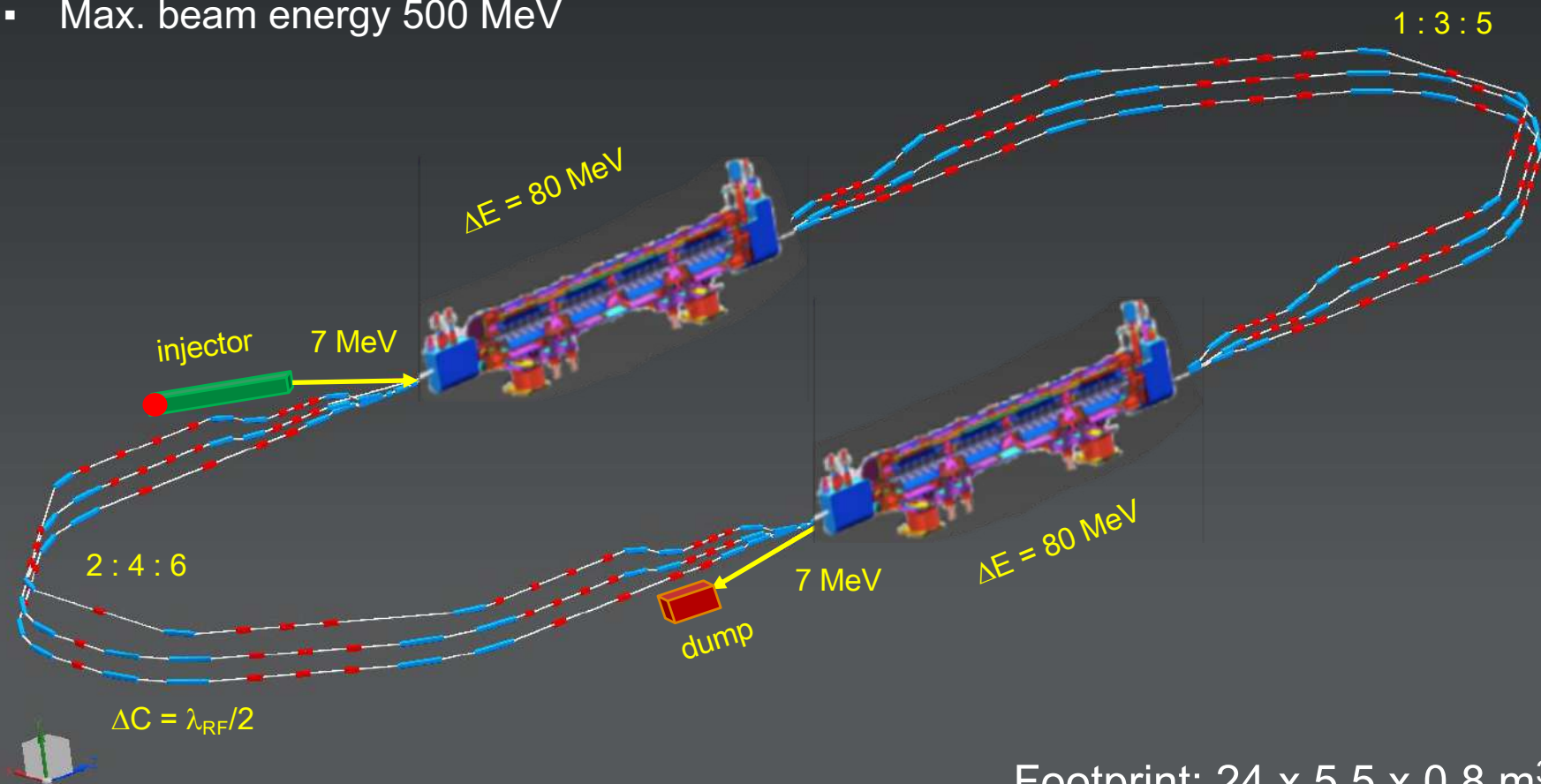

Footprint: 24 x 5.5 x 0.8 m³

PERLE configuration:

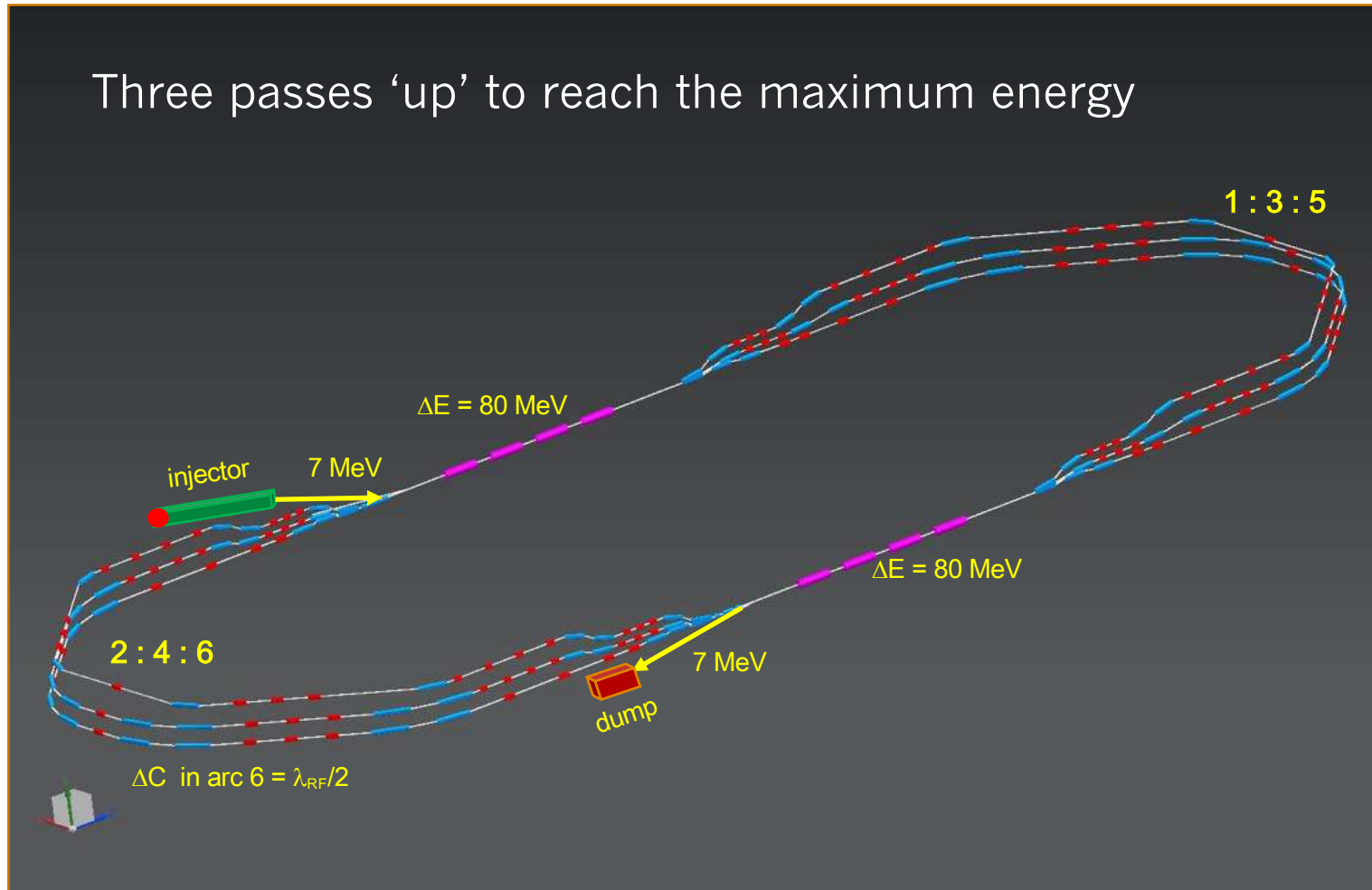

PERLE configuration:

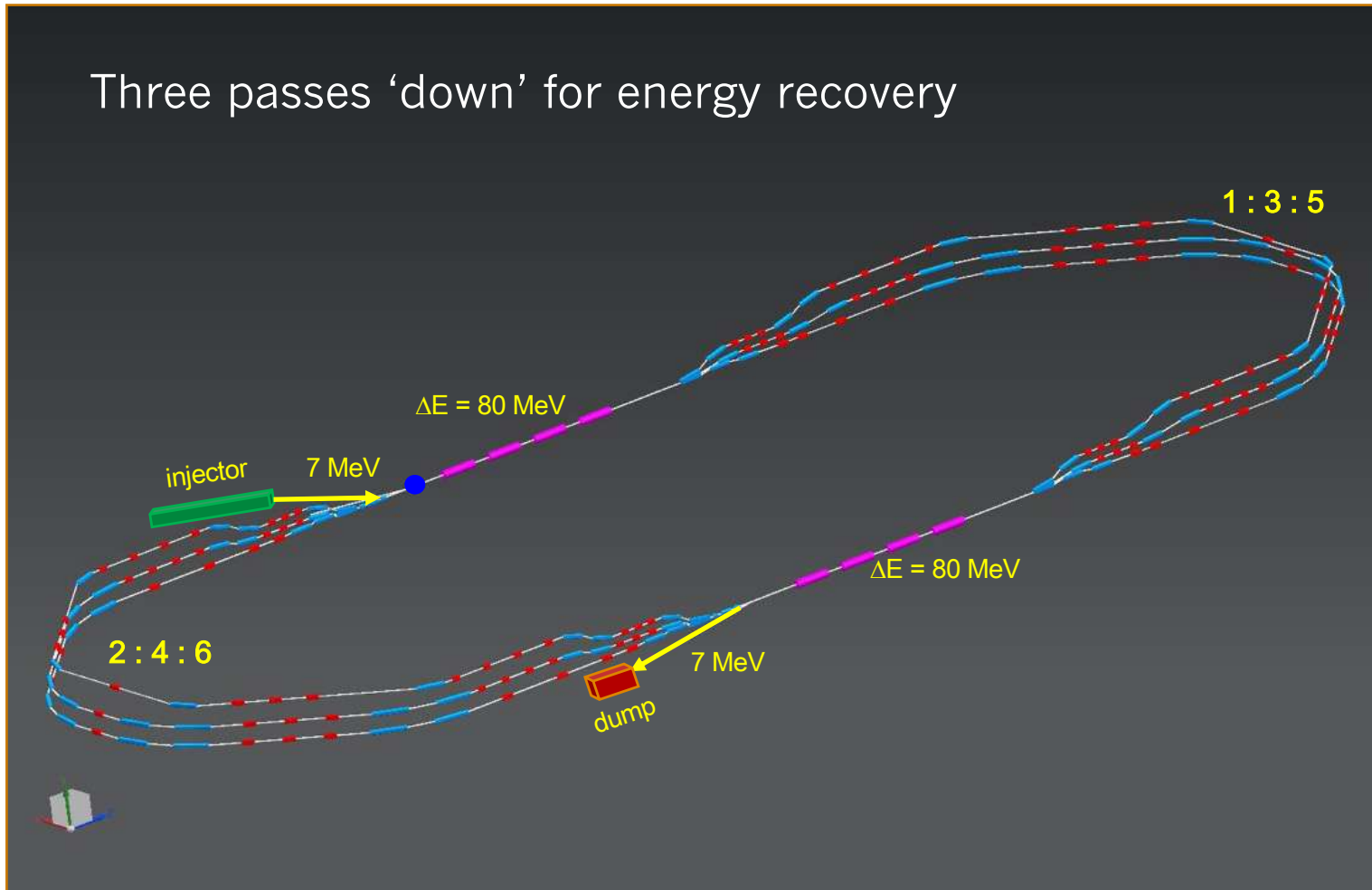

Motivations to study, then host an ERL at Orsay:



Why an ERL:

- A clever concept: Accelerate electrons to high energy, use the beam, decelerate and recover the beam energy for machine operation.
- Saving energy is a key word for future machine construction.
- Compact accelerator with high performances, smaller infrastructures (site area, cryogenic plant...)

Why @ Orsay:

- Develop and acquire expertise in design and operation of ERL.
- Involvement of local accelerator experts with complementary expertise around an ambitious project.
- Opportunity to host the first superconductive R&D test facility.

Motivations to study, then host an ERL at Orsay:



Why PERLE:

- The opportunity to work within an international collaboration with expert in ERL design and operation.
- Technical challenges imposed by the machine design:
 - Multi-pass energy recovery,
 - High power operation,
 - SR cavities test with beam,
 - beam stability (intensity, position and size) in acceleration and deceleration phases,
 - Injector versatility,
- To prepare technology for the future machine.
- Compact but powerful machine that could allow many applications: (controlled quench tests in SC cables and magnet, Beam diagnostics development, injector studies, test facility for cryomodules, detector development and test).

PERLE transport optics:

Appropriate recirculation optics are of fundamental concern in a multi-pass machine to preserve beam quality. The design comprises different regions:

- **The Linac optics:** The focusing strength of the quadrupoles along the linac needs to be set to transport co-propagating beams of different energy and to support a large number of passes.
- **The Spreader optics:** The beams need to be directed into the appropriate energy dependent arc. Spreaders separate vertically beams and match optics functions to arcs.
- **The Arc optics:** Disturbing effects on beam space charge such as cumulative emittance and momentum growth have to be counteracted through a pertinent choice of the basic optics cell
- **The Re-combiner optics:** Re-combiners and spreader are mirror symmetric.

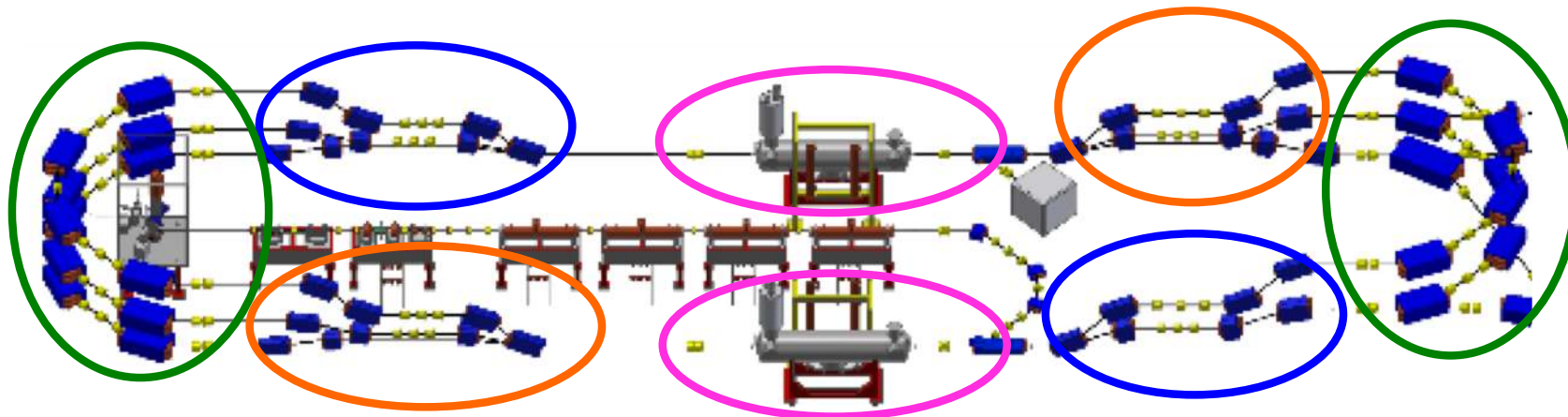

Multi-pass Energy Recovery optics:



Alex Bogacz-JLAB

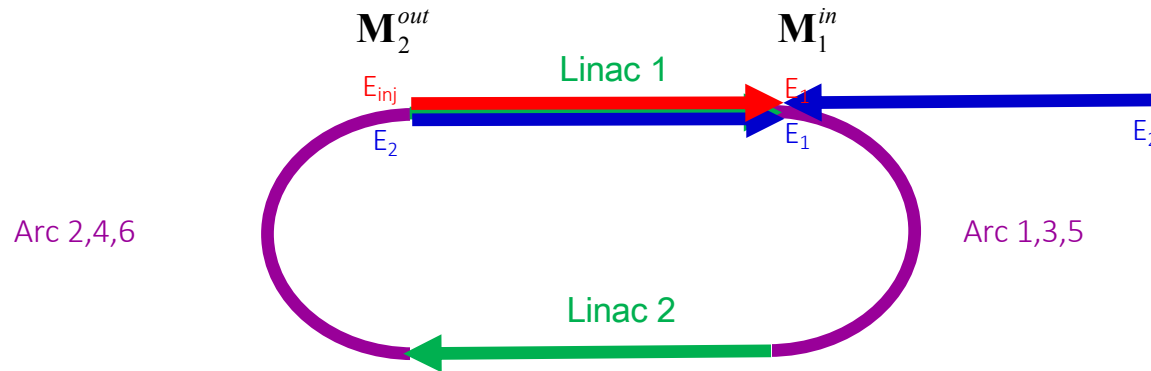

$$\mathbf{M} = \begin{bmatrix} \beta_x \\ -\alpha_x \\ \beta_y \\ -\alpha_y \end{bmatrix}$$

Linac 1

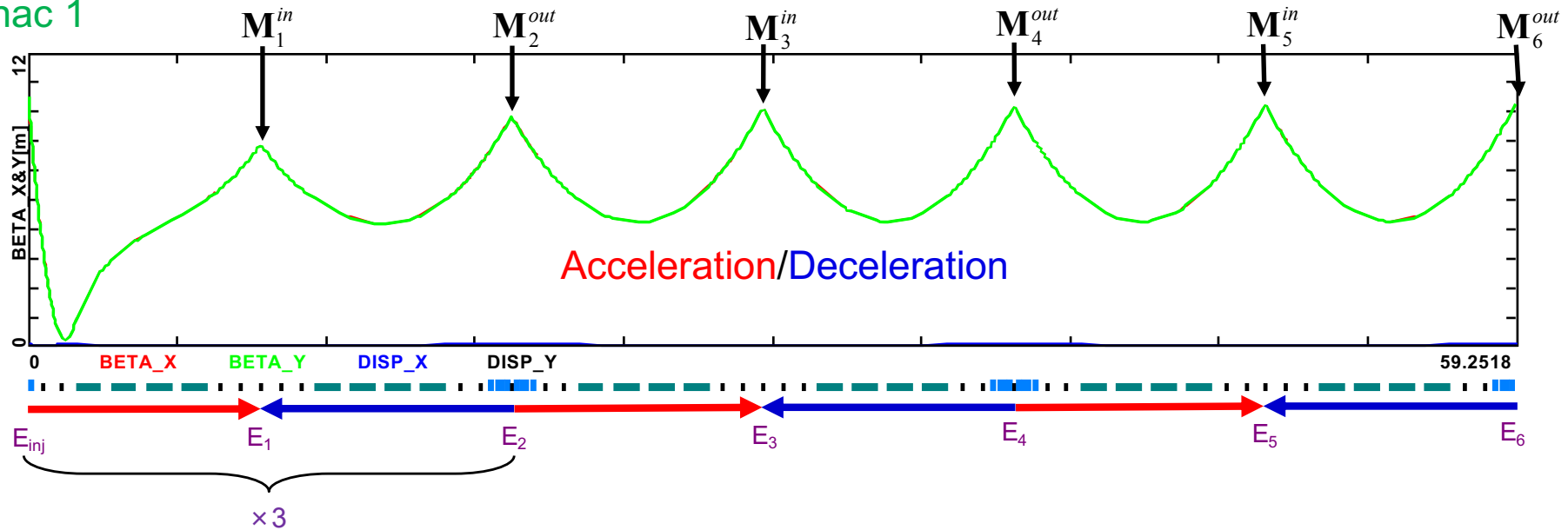

Multi-pass Energy Recovery optics:

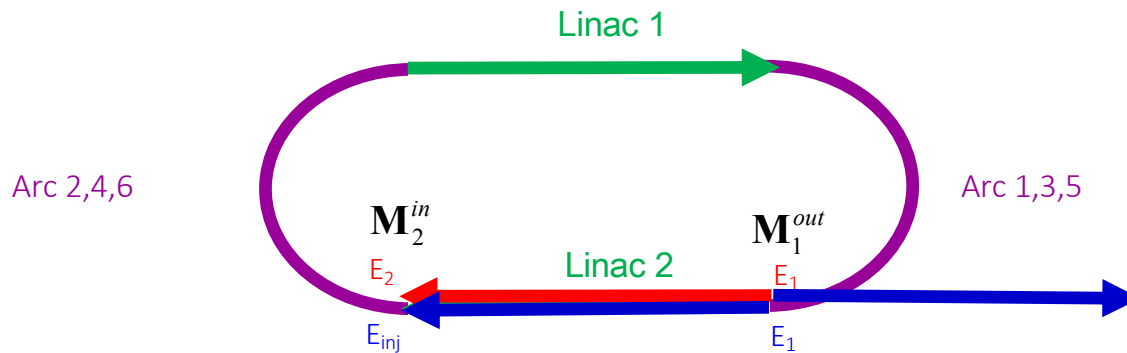

$$M = \begin{bmatrix} \beta_x \\ -\alpha_x \\ \beta_y \\ -\alpha_y \end{bmatrix}$$

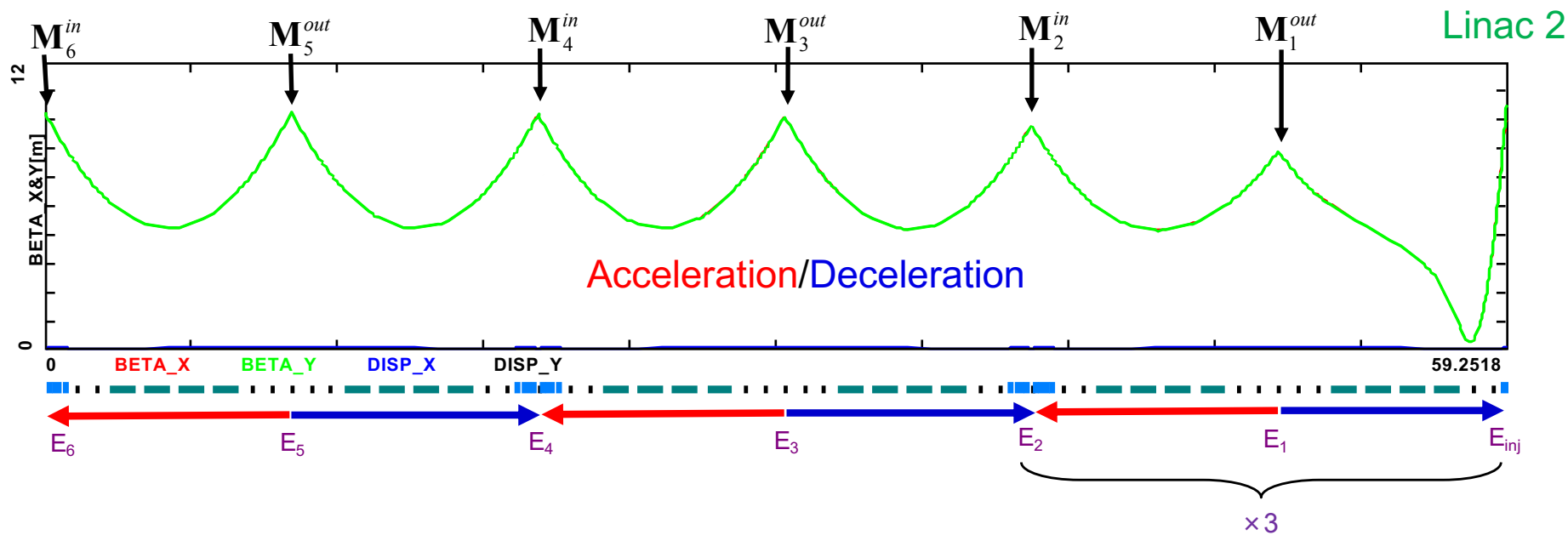

Switchyard- Vertical Separation of Arcs (1, 3, 5):

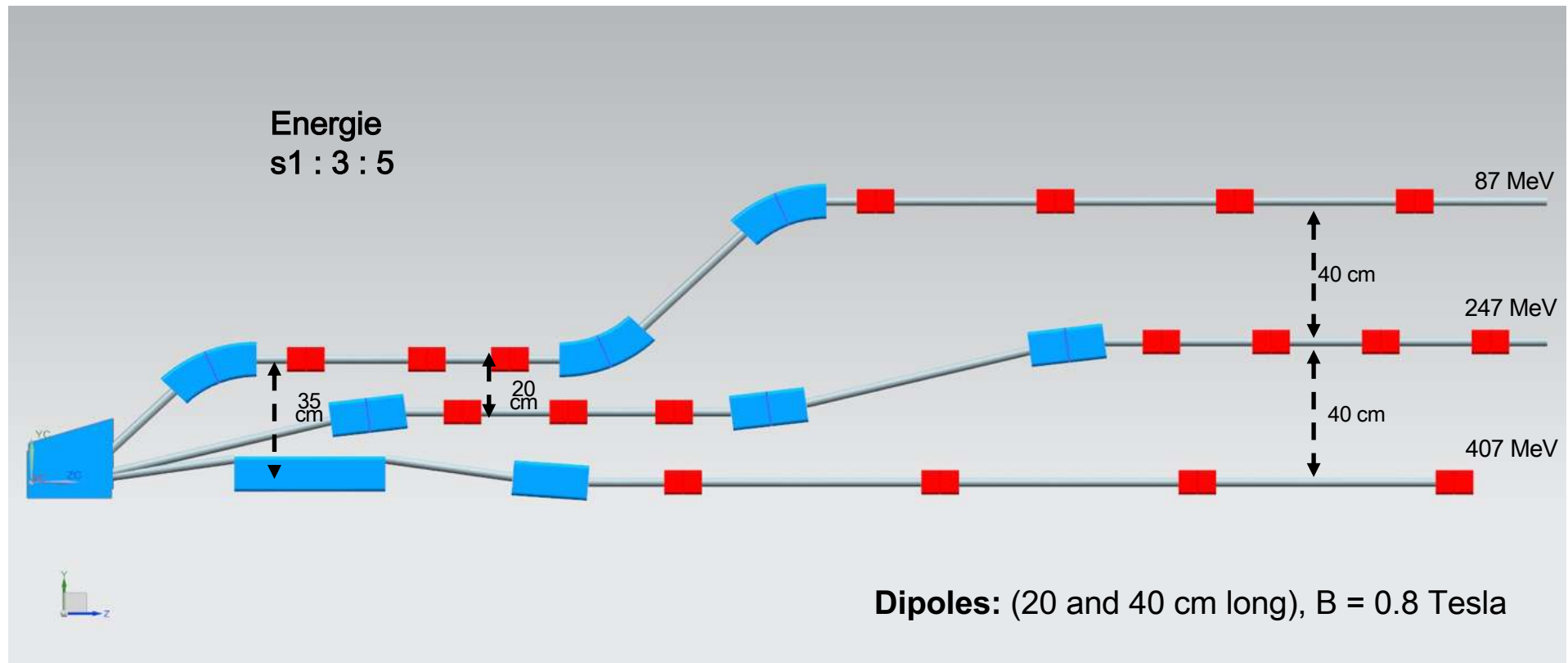

Arc optics, Arc 1 (71 MeV) as example:

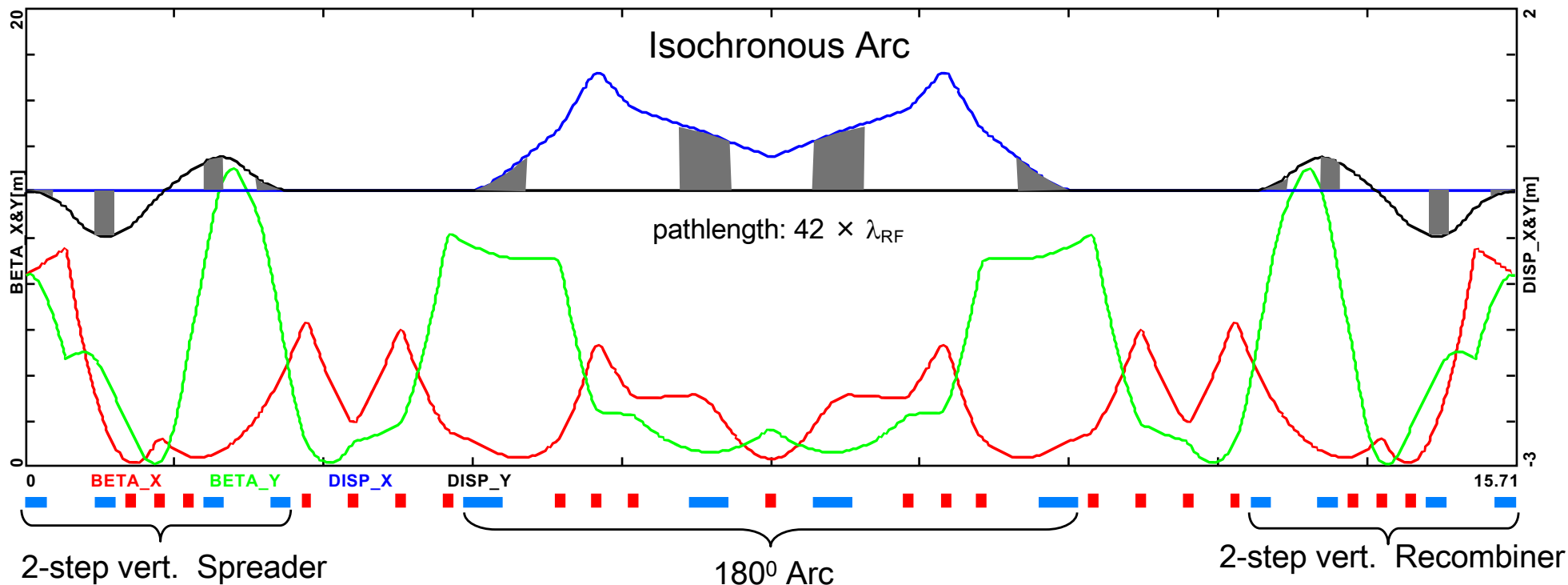

Spr. dipoles:
 4× 45° bends
 L = 20 cm
 B = 9.5 kGauss

Arc dipoles :
 4×45° bends
 L = 45.6 cm
 B = 4.5 kGauss

Rec. dipoles:
 4× 45° bends
 L = 20 cm
 B = 9.5 kGauss

quads: L = 10 cm G ≤ 1 kGauss/cm

1 pass up + 1 pass down optics:



Pass-1 'up'

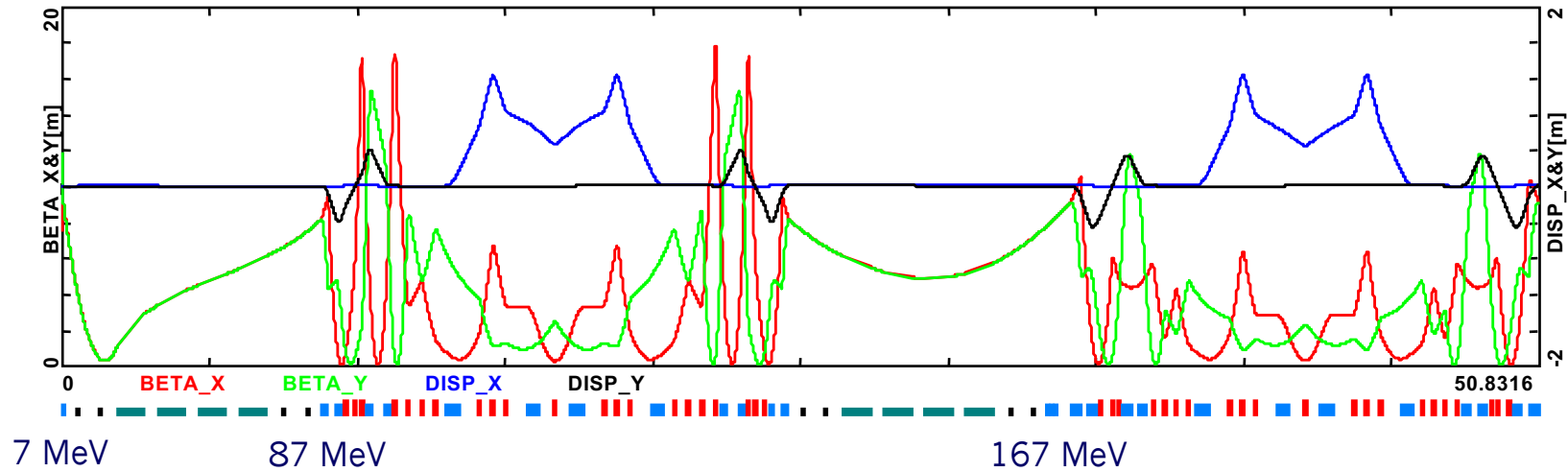

Pass-1 'down'

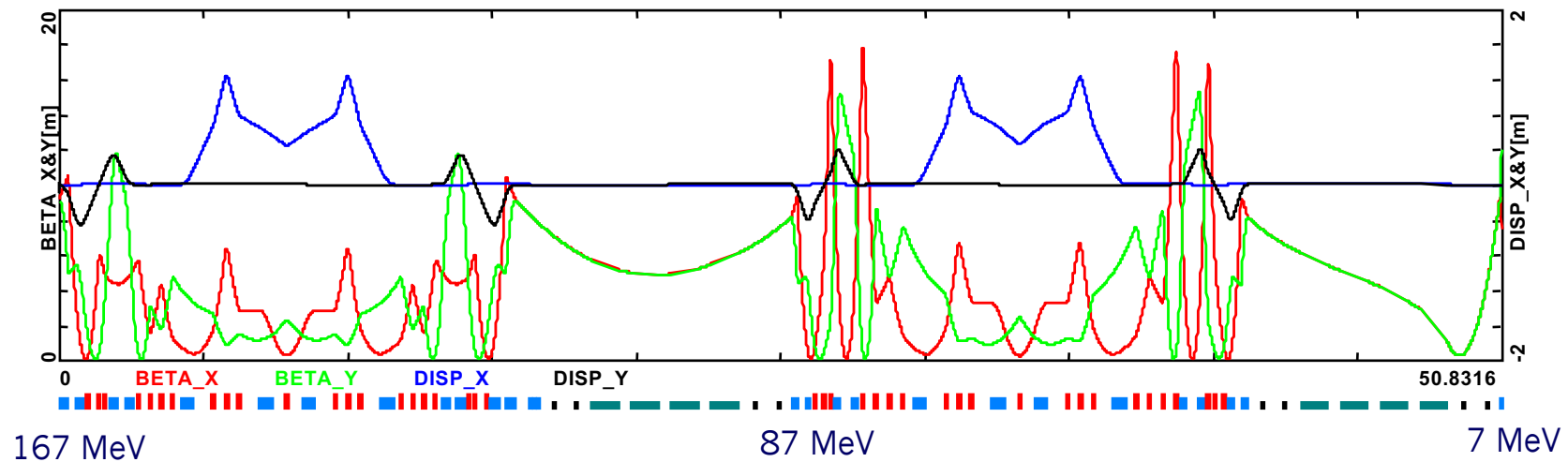

Bunch recombination pattern:

- Basic RF structure, without recirculation: Bunches are injected every 25 ns

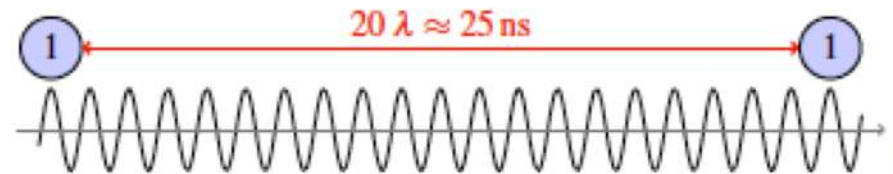

- When recirculation occurs → bunches at different turns in the linacs:
 - Ovoid bunches in the same bucket
 - Recombination pattern adjusted by tuning returned arcs length of the required integer of λ

Turn number	Total pathlength
1	$n \times 20\lambda + 7\lambda$
2	$n \times 20\lambda + 6\lambda$
3	$n \times 20\lambda + 3.5\lambda$

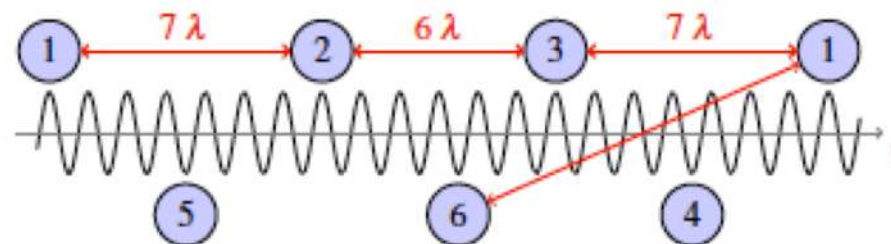

- Maximize the distance between the lowest energy bunches (1 & 6): ovoid reducing the BBU threshold current due to the influence of HOMs kicks
- Achieve a nearly constant bunch spacing: minimize collective effects

Cost-effective magnet solution:



Cynthia Vallerand (LAL) & Pierre Thonet (CERN)

- Iron-dominated resistive magnets preferred for improving tunability
- Magnet aperture of +/- 20 mm
- Current density of 7-8 A/mm²
- H design to reduce the magnet height for stacking
- Homogeneous field as low as possible due to the use of one power supply by arc
- Cost minimization with a design of the arc magnets coupled to studies of the power converters, the vacuum system and cooling as well as only one magnet per bend with a 45° deflection

Arc	Energy [MeV]	Count	angle [deg]	B [T]	L [mm]	Curv. radius [mm]	Pole gap [mm]	GFR width [mm]	
#1	80	4	45	0.45	456	596	±20	±20	MBA
#2	155	4	45	0.87	456	596	±20	±20	
#3	230	4	45	1.29	456	596	±20	±20	
#4	305	4	45	0.85	912	1191	±20	±20	MBB
#5	380	4	45	1.06	912	1191	±20	±20	
#6	455	4	45	1.27	912	1191	±20	±20	

PERLE magnet design (dipoles and quadrupoles):



70 dipoles 0.45-1.29 T

+/- 20 mm aperture, $l=200,300,400$ mm

May be identical for hor+vert bend

7A/mm² (in grey area) water cooled

DC operated

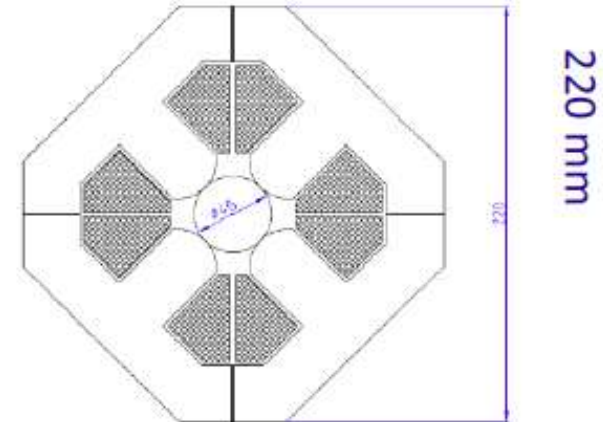
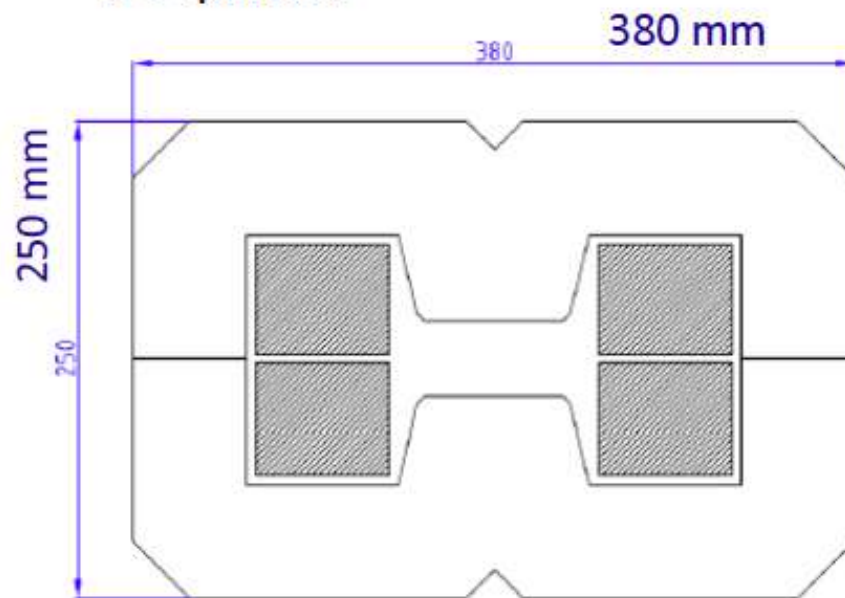

114 quadrupoles max 28T/m

Common aperture of 40mm all arcs

Two lengths: 100 and 150mm

DC operated

P Thonet, A Milanese (CERN), C Vallerand (LAL), Y Pupkov (BINP)

PERLE magnet design:



Simulations for magnet design optimization.

→ Main concern: magnet compactness configuration in spreaders and combiners: magnet saturation risk, cross-talk between magnets.

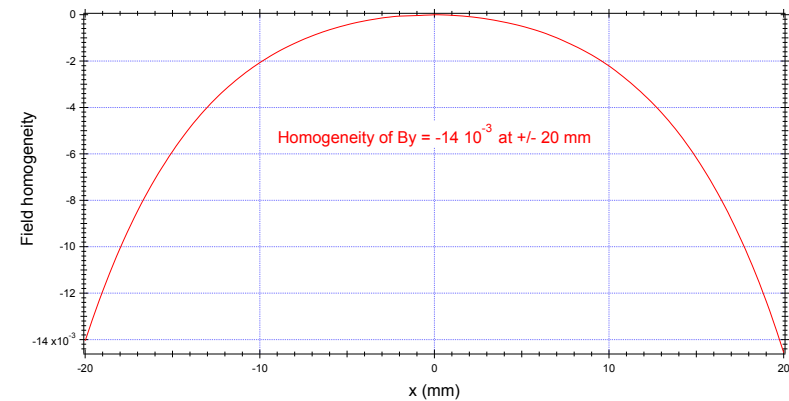
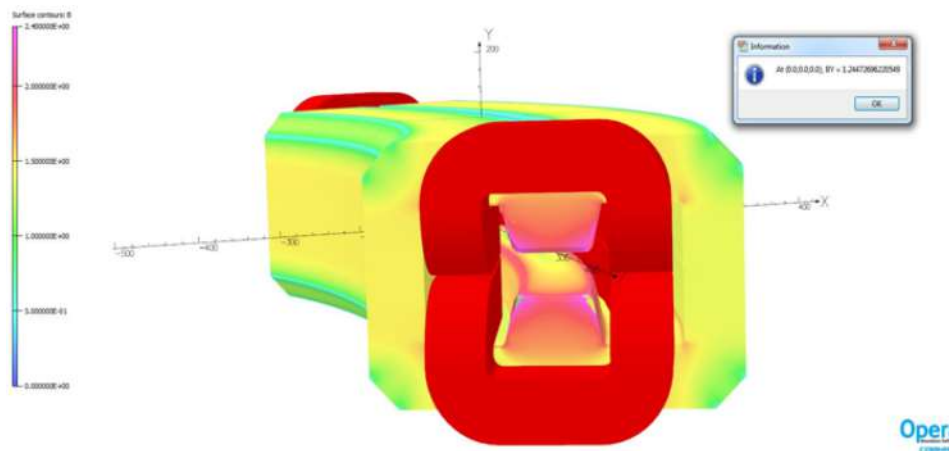

3D Simulation results from 2D design with bedstead coils

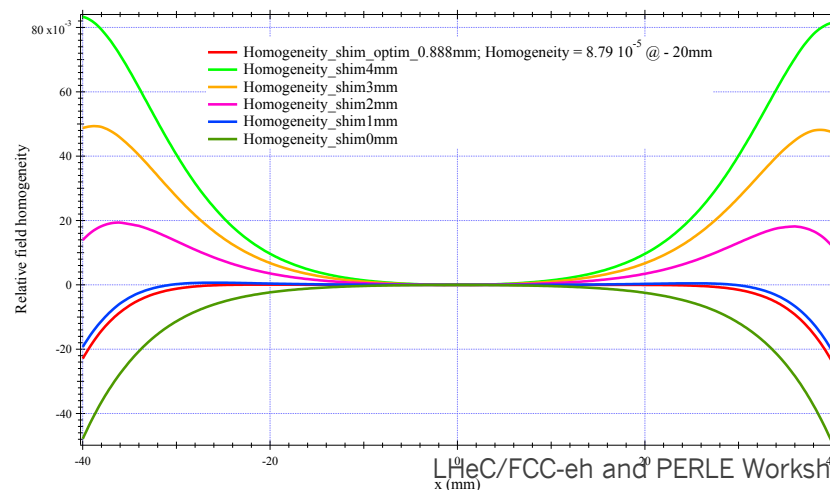

Bending magnets: field homogeneity with optimized shim of $8.8 \cdot 10^{-5}$ at ± 20 mm (GFR), better than expected ($5 \cdot 10^{-4}$).

Electron source and injector:



Boris Militsyn & Benjamin Hounsell- Daresbury

The PERLE injector consists of:

- The upgraded DC photoemission electron gun of ALICE.
- A bunching and focusing section: 401 MHz or 802 MHz normal conducting buncher cavity placed between two solenoid.
- A superconducting booster with 5 single cell 802 MHz cavities with individual control of the amplitudes and phases.
- Merger to transport the beam into the main LINAC,
- Beam diagnostics to be placed between components.

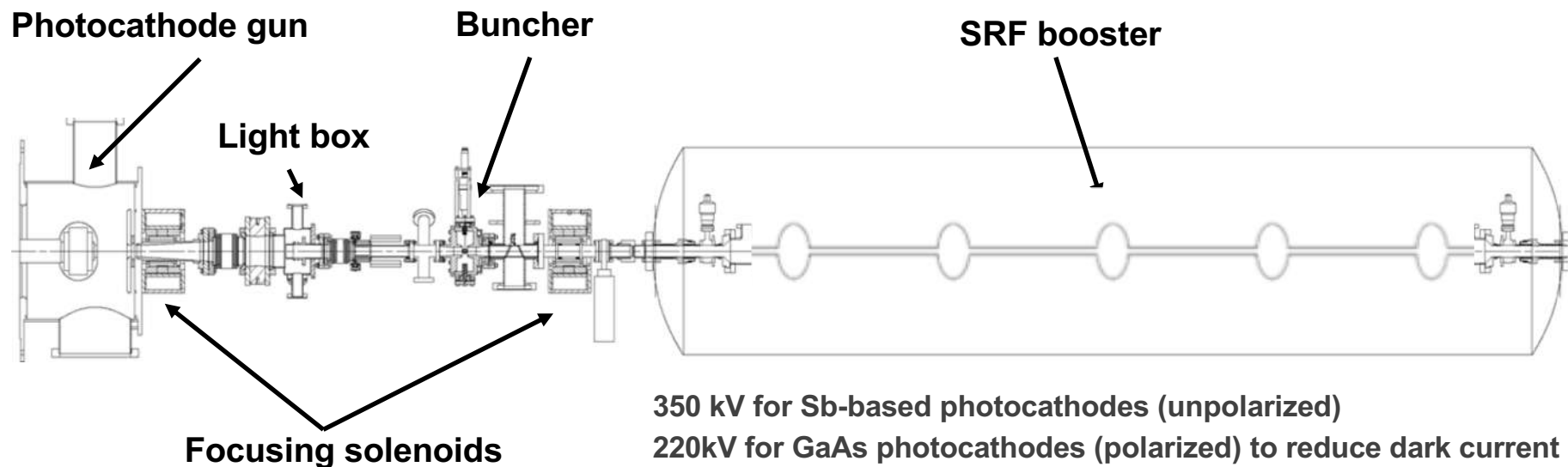

Electron source and injector:



Photocathode gun

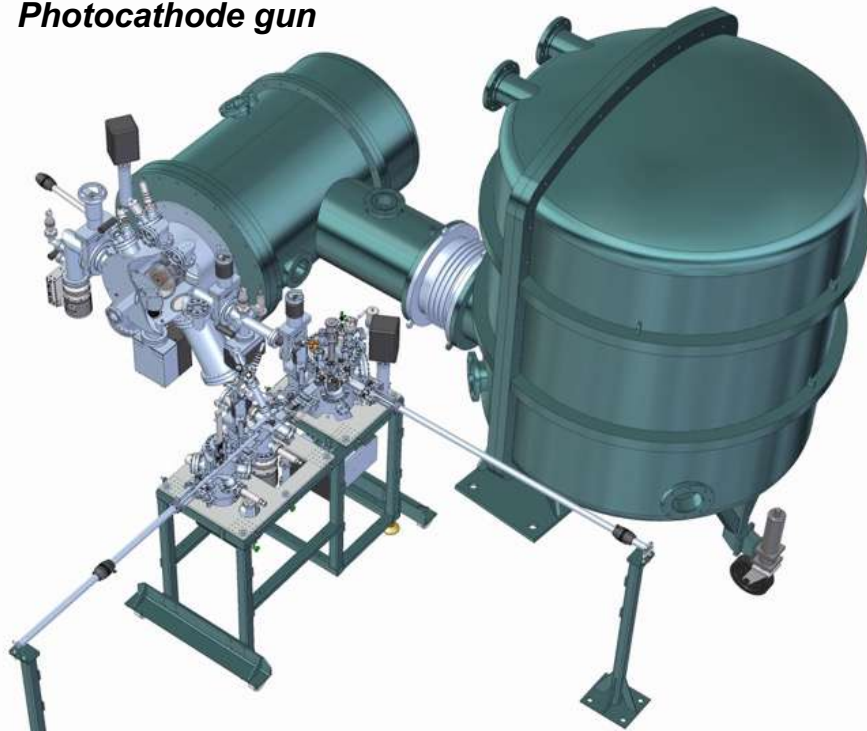

Photocathode preparation facility

500kV power supply

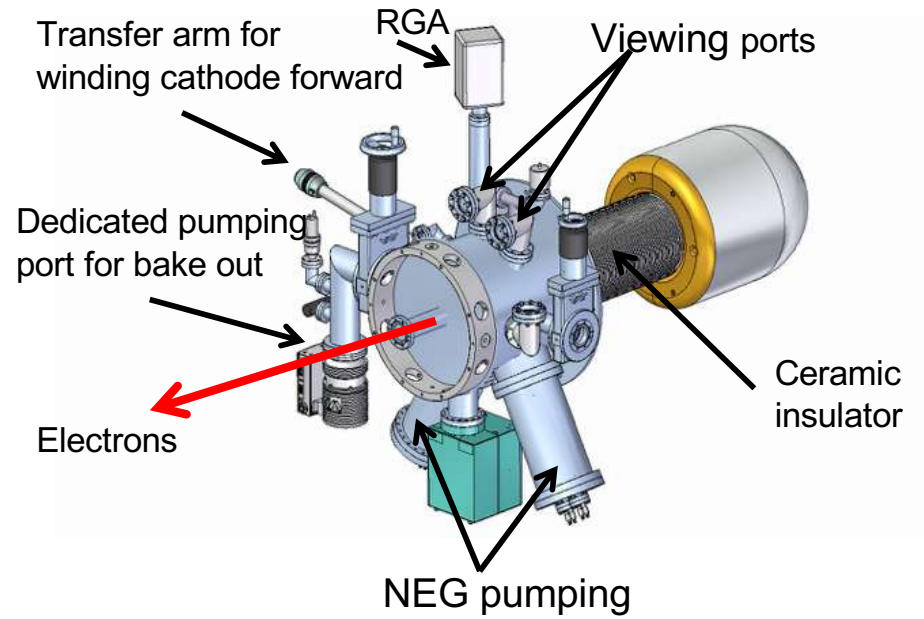

Ongoing studies at Daresbury for ALICE gun upgrade to operate at up to 500 pc:

- Optimisation of the laser spot size, laser pulse length, cathode-anode gap and the cathode shape to preserve the emittance in the gun and first solenoid section and to reduce transverse beam size in the focusing and bunching section,
- Optimise the buncher frequency (401 MHz or 802 MHz) in order to minimise emittance growth,
- Optimise beam transport from the gun to the booster to minimise transverse beam size and compensate emittance.

Main cavity parameters:



Frank Marhauser-JLAB

Parameter	Unit	Value
Frequency	MHz	801.58
Number of cells		5
Iris/tube ID	mm	130
L_{act}	mm	917.9
$R/Q = V_{eff}^2 / (\omega \cdot W)$	Ohm	524
G	Ohm	274.7
R/Q·G/cell		143940
$\kappa_{ }$ (2mm rms bunch length)	V/pC	2.74
E_{pk}/E_{acc}		2.26
B_{pk}/E_{acc}	mT/(MV/m)	4.20
k_{cc}	%	3.21

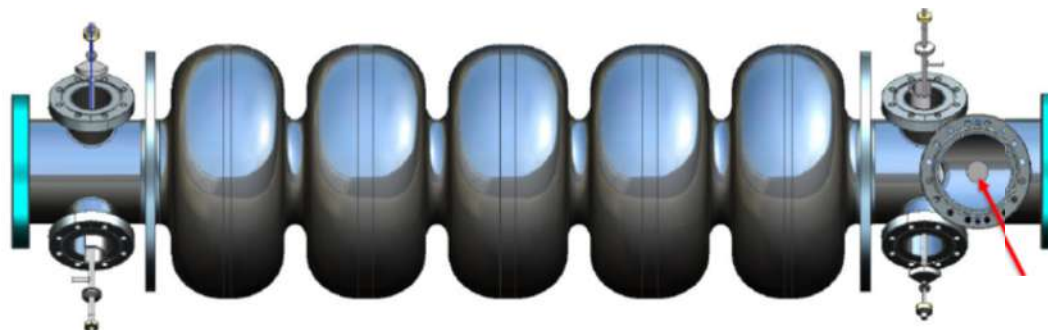

Cavity fabrication and test:



The first Nb 802 MHz 5-Cell cavity
fabricated October 2017 at JLAB

Cavity fabrication and test:



5-cell cavity successfully electropolished with new flange adapters

Cavity fabrication and test:

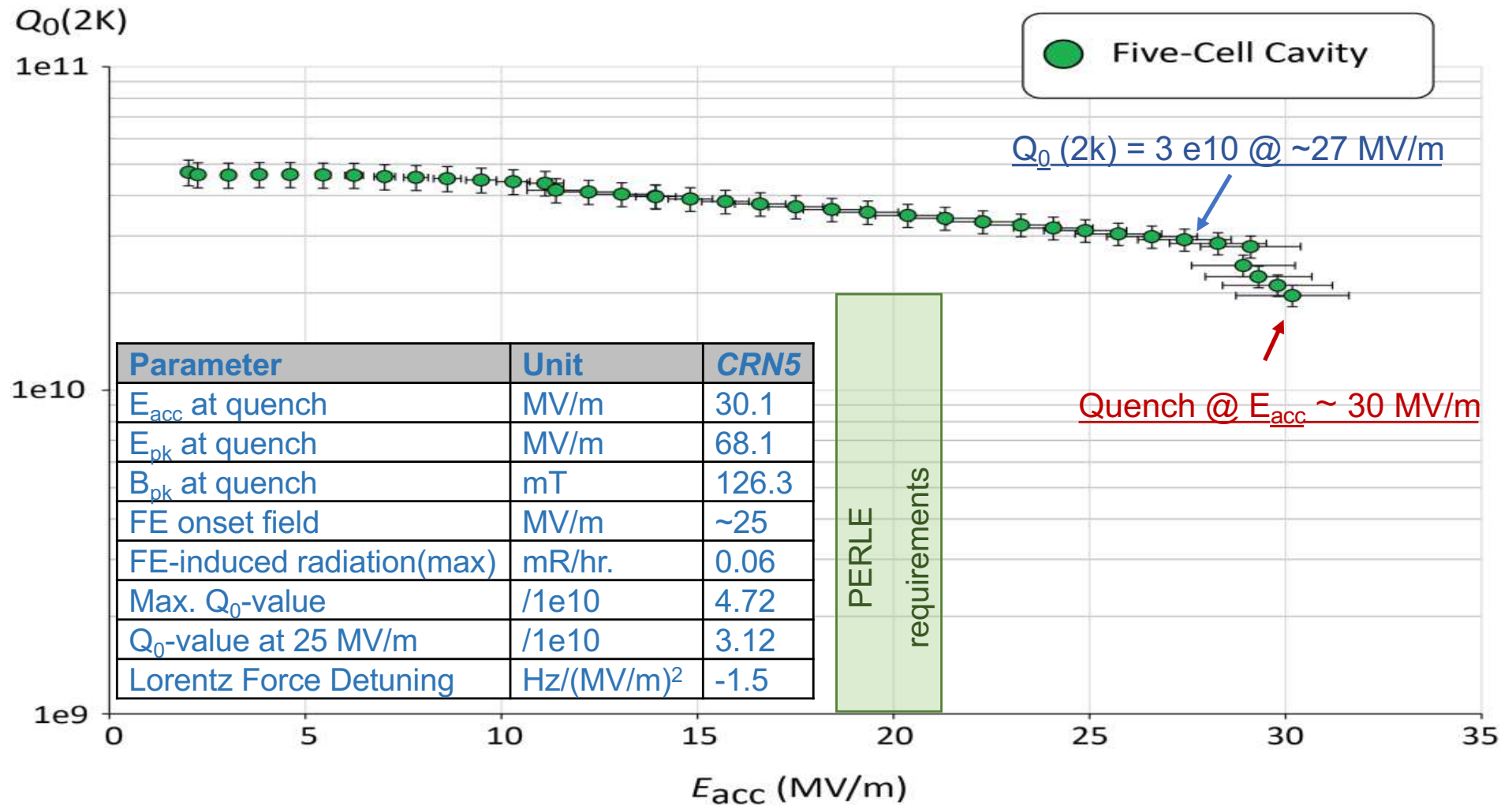

For more details: F. Marhauser's talk in the FCC Week, April 2018, Amsterdam, Netherland

Cryomodule design study:



IPN-Orsay & CERN, started the study of the SPL cryomodule adaptation for PERLE.

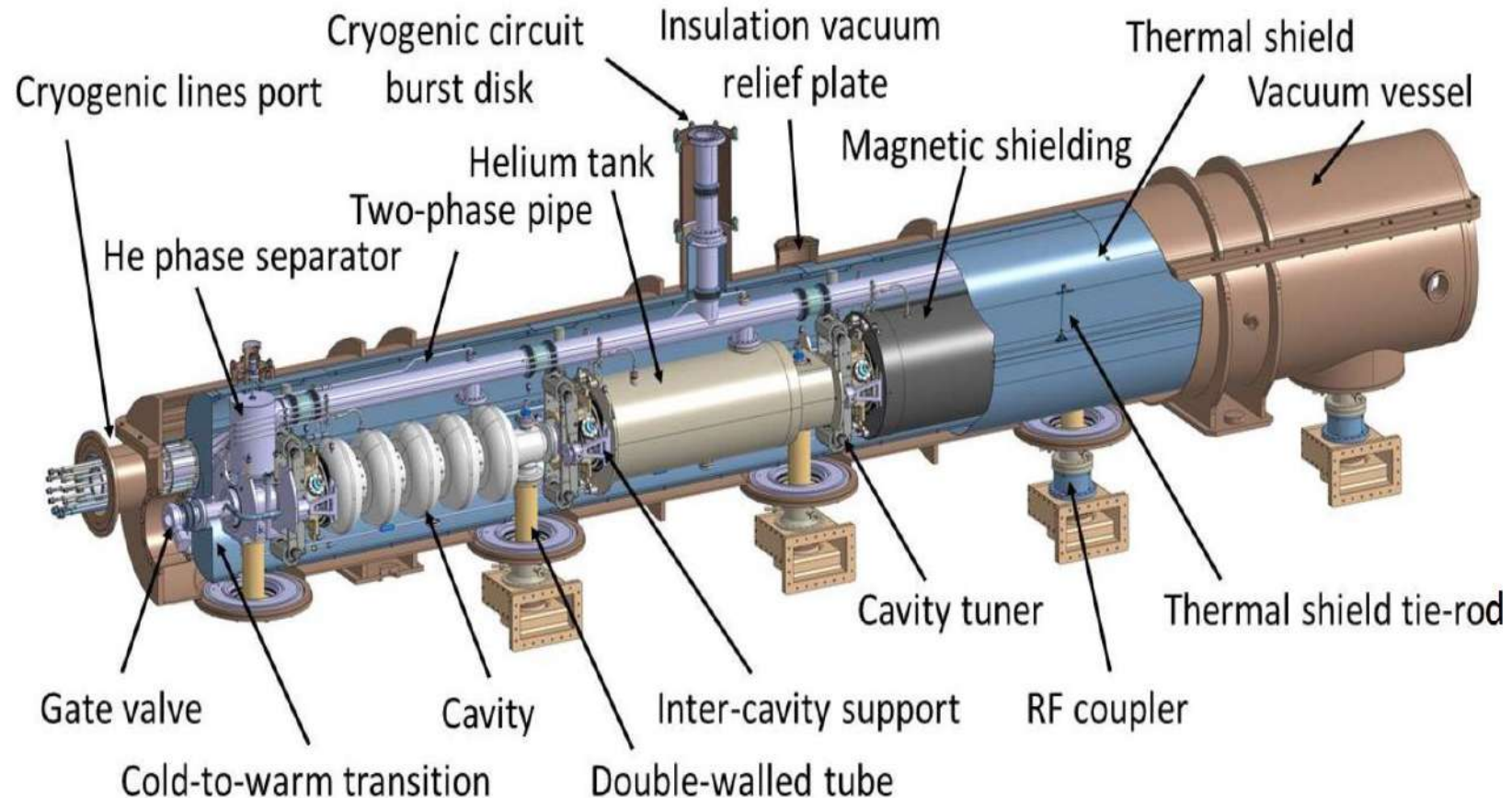

SPL cryomodule: designed to integrate 4 elliptical 5-cells 704 MHz cavities

Cryomodule design study:



First results:

- Thermal and magnetic shielding are well sized for PERLE operation parameters,
- Input coupler designed for SPL cavity could be easily adapted to meet PERLE requirement,
- Space liberated due to cavity frequency difference give a margin for auxiliaries integration,

Pending issues:

- HOM study will define the design and the number of HOM couplers to be used →
Will define the final decision to adapt the SPL cryomodule for PERLE or not.

HOM studies

Several HOM coupler types were investigated for adaptation to the new cavity :



HOM 'Y' end-group with 3 coaxial couplers (here with scaled TESLA-type couplers)

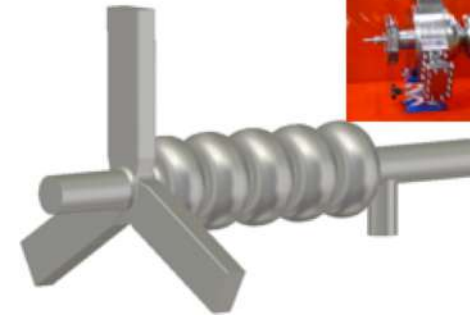

HOM 'Y' 'High Current' waveguide coupler end-group



LHC Probe-type

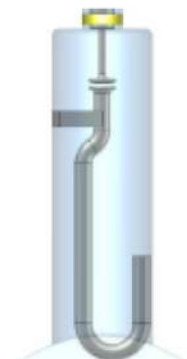

LHC Hook-type

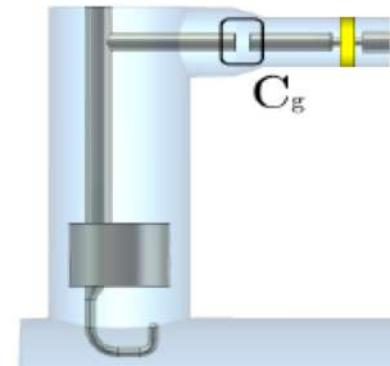

DQW HOM Coupler

Next steps



- Formalize the collaboration in the coming months by signing the MoU between PERLE collaboration members. Interested lab/institutions are welcome to join!
- Draft the PERLE TDR by mid 2020.
- Parallel to the TDR writing, a prototyping activity on key components based on lab internal funds or in-kind contributions
 - Cavities and cryomodule (fully dressed cavities, prototype cryomodule) within the 3 next years,
 - Injector (upgrade of Alice injector)
 - Magnets (build of prototype of each type)
- Define and set a list of key scientific cases for PERLE
 - ERL Accelerator demonstrator
 - Gamma ray beam generation
 - Electron proton scattering
 - Nuclear physics: electron diffusion on radioactive ion beams

Thank you for your attention



La jeune fille à la perle- J. Vermeer (1665)

Hosting PERLE at Orsay:

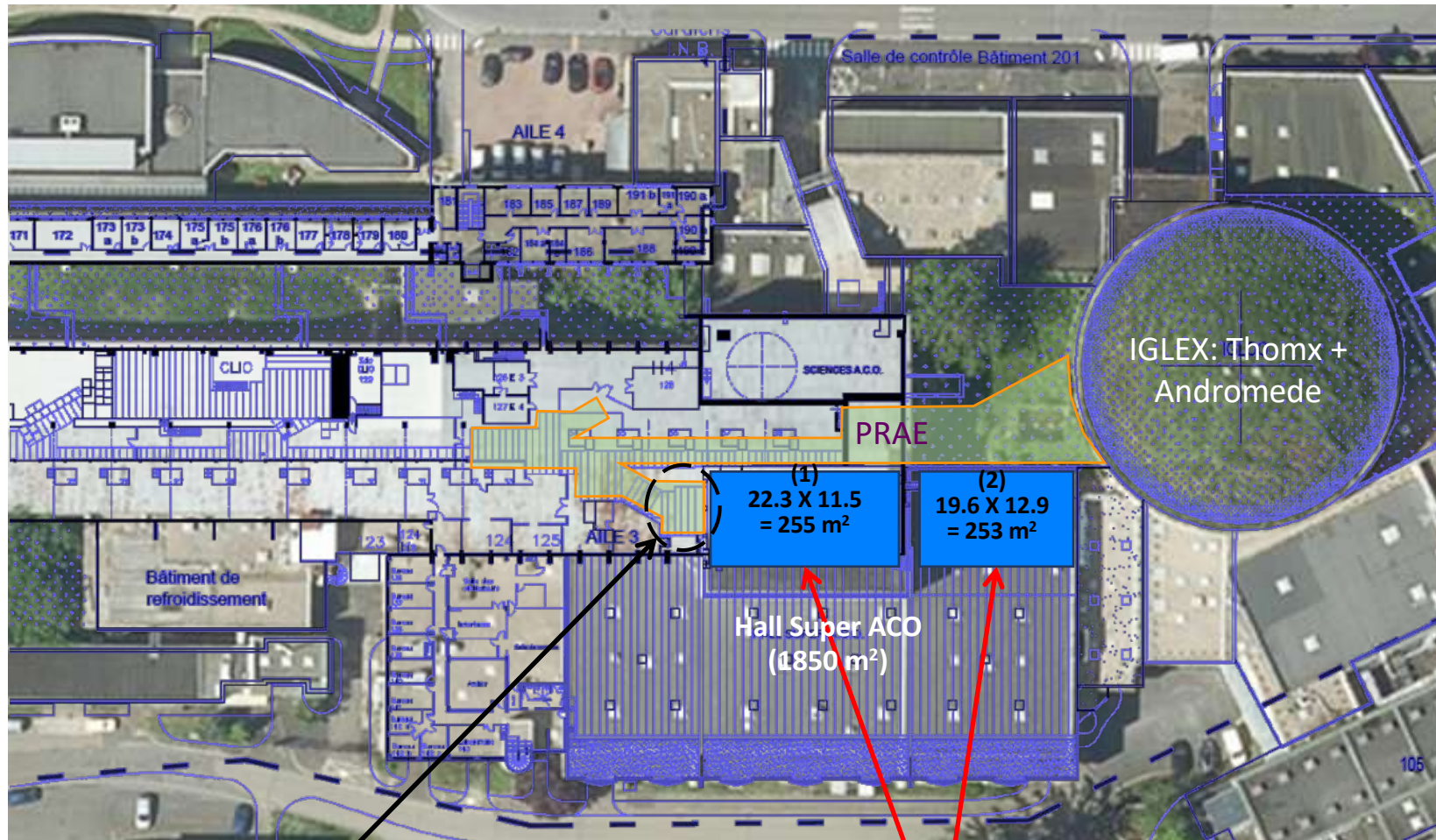

Possible use of a 2nd levels for RF source installation

2 possible locations to install Perle@Orsay

Hosting PERLE at Orsay:



Next steps



Important R&D effort still to be done in several fields:

- Linear lattice optimization and Initial magnet specifications
- Correction of nonlinear aberrations (geometric & chromatic) with multipole magnets
- Beam Dynamics (start to end simulation with synchrotron radiation, CSR and micro-bunching, Multi-particle tracking studies of halo formation)
- Injection line/chicane design
- Space-charge studies at injection
- Final magnets and power supplies specifications
- Beam dumps optimization
- RF power source specification
- Cryogenics optimization
- Beam instrumentations
- LLRF
- Control software system
- Shielding and safety system