

PAON4: NOISE MAPS

ANALYSIS OF STATISTICAL NOISE

Area study: 22 August 2018.

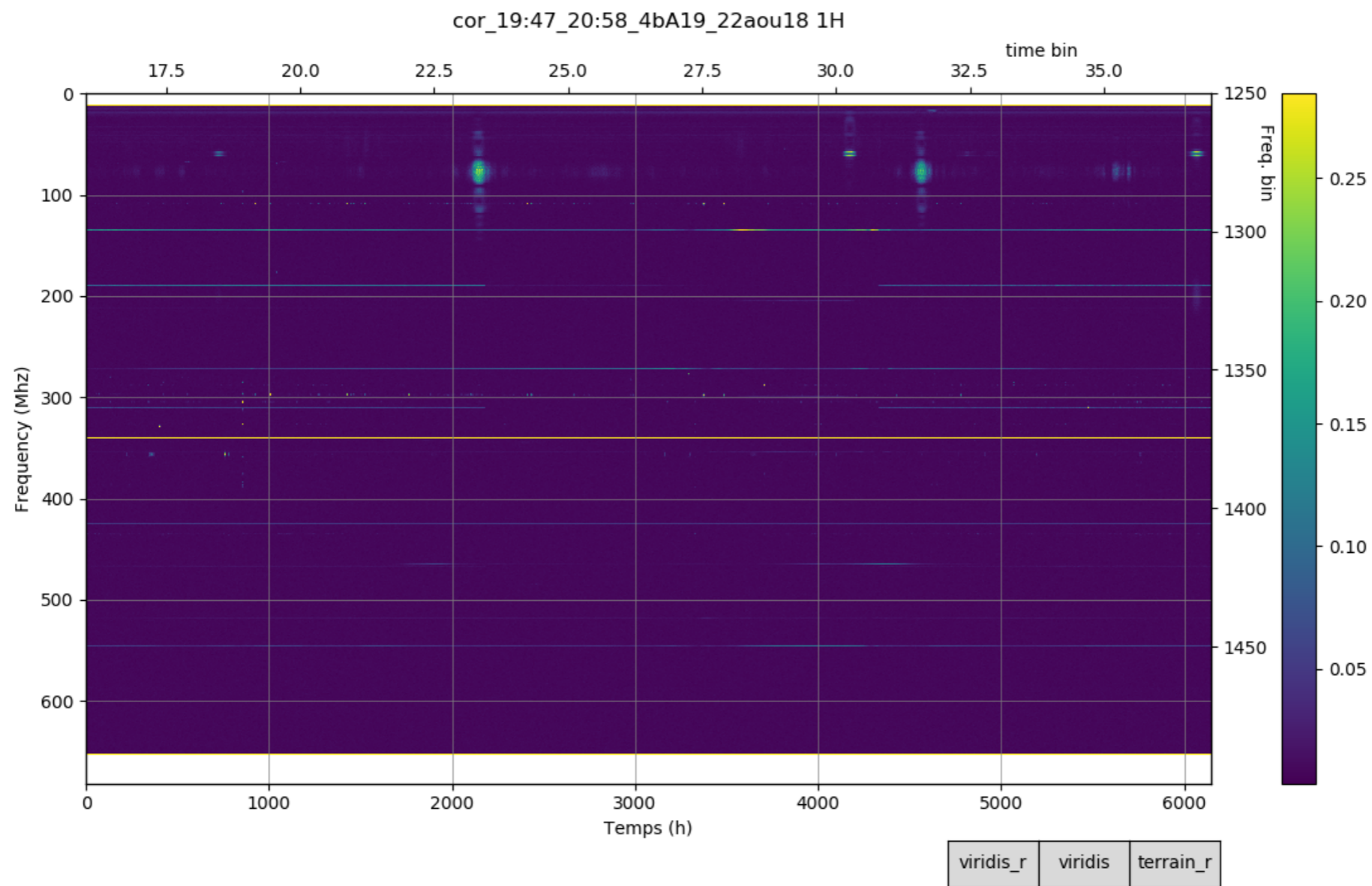

All day recording

Time Frecuency map of 2019-05-24T12:39:19

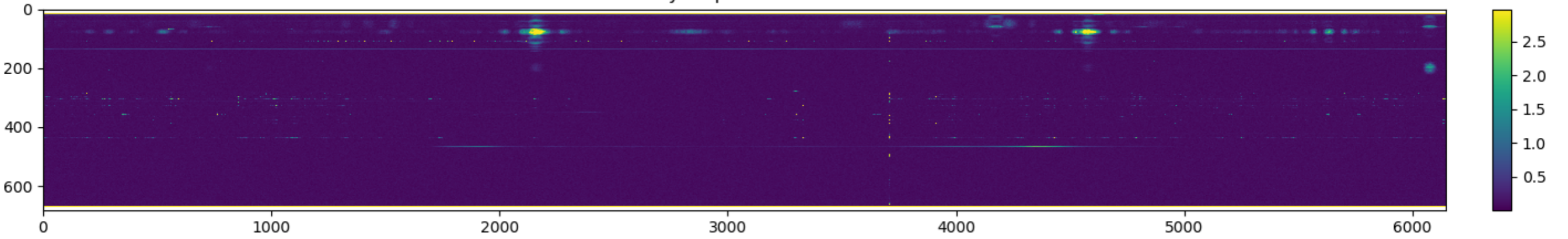

Zoom Selection : Between 26.4025 h and 27.8588 h

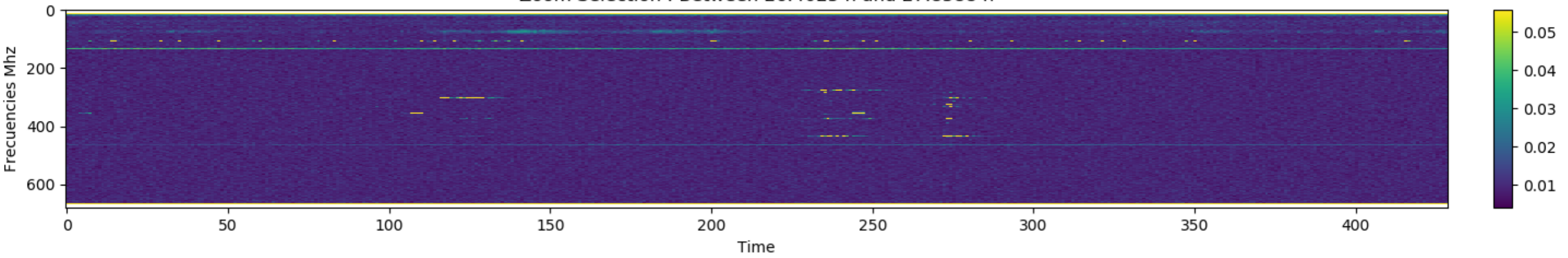

Zoom Selection : Between 27.4649 h and 27.5804 h

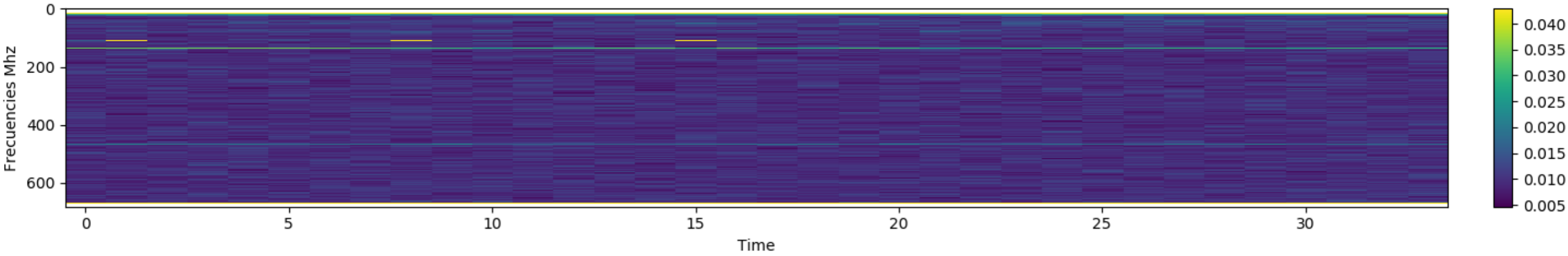

Here the 2D Map of 2019-05-24T12:39:19 ----- Time interval selected in t_scan()

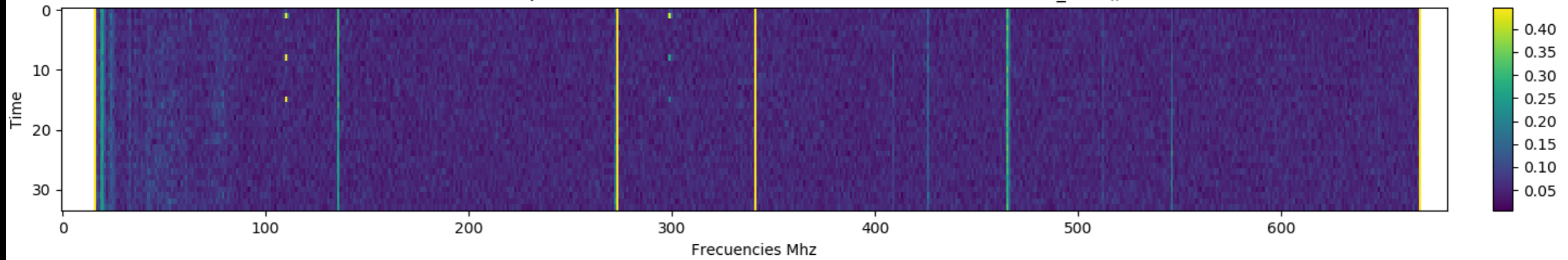

Zoom Selection : Between 1308.6243 Mhz and 1344.5129 Mhz

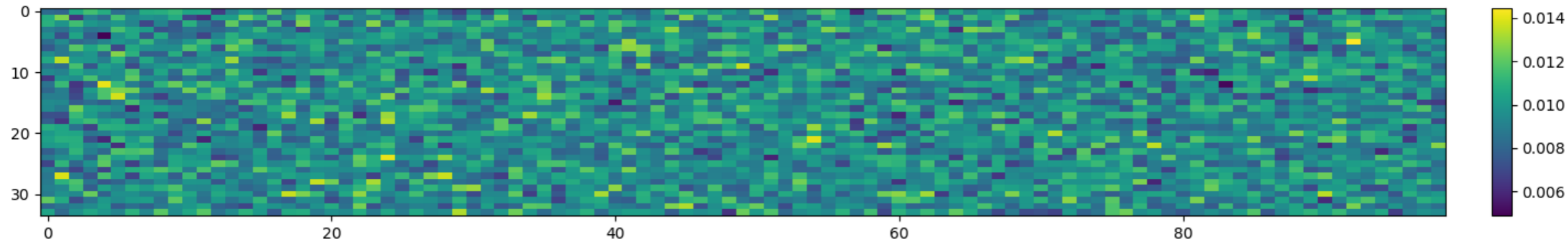

Zoom Selection : Between 1308.6243 Mhz and 1343.7805 Mhz

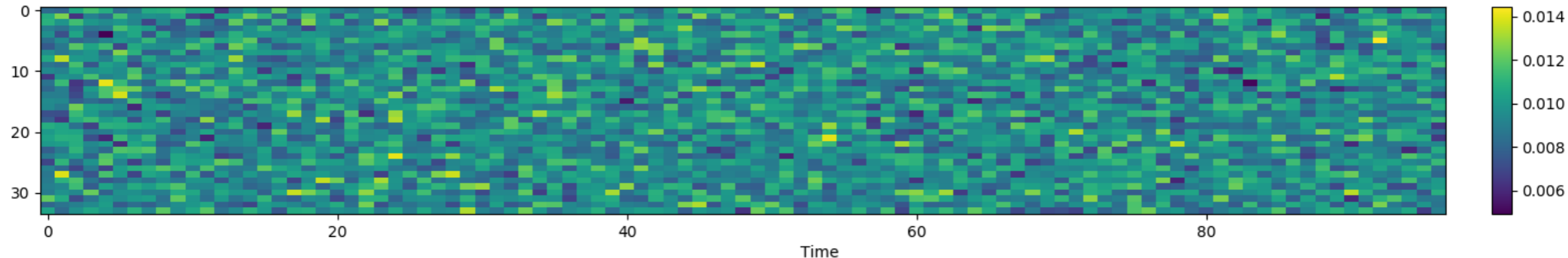

Average in time of counts-- : restricted zone time-frecuencie

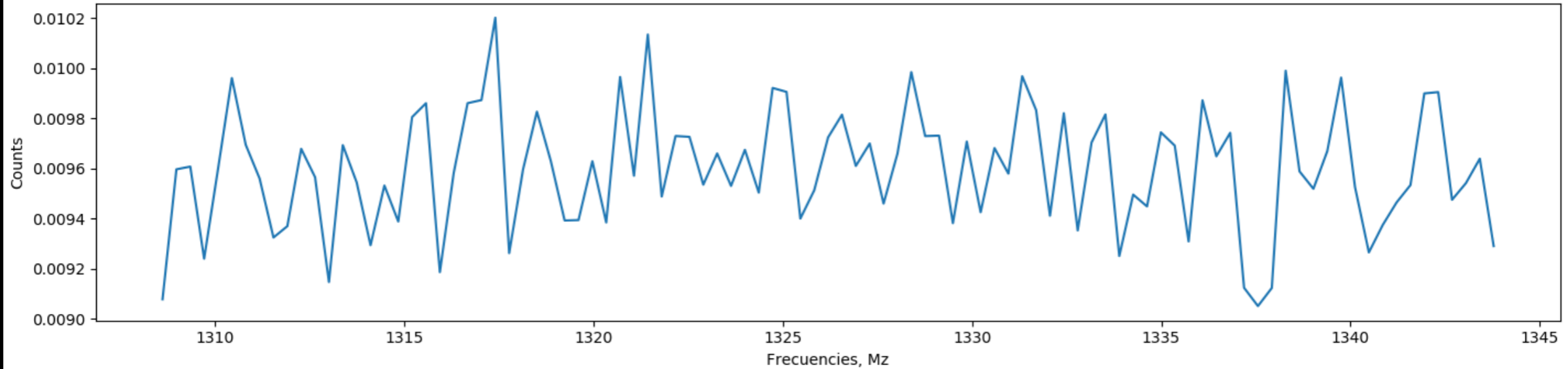

Here the 2D Map of 2019-05-24T12:39:19 ----- Time interval selected in t_scan()

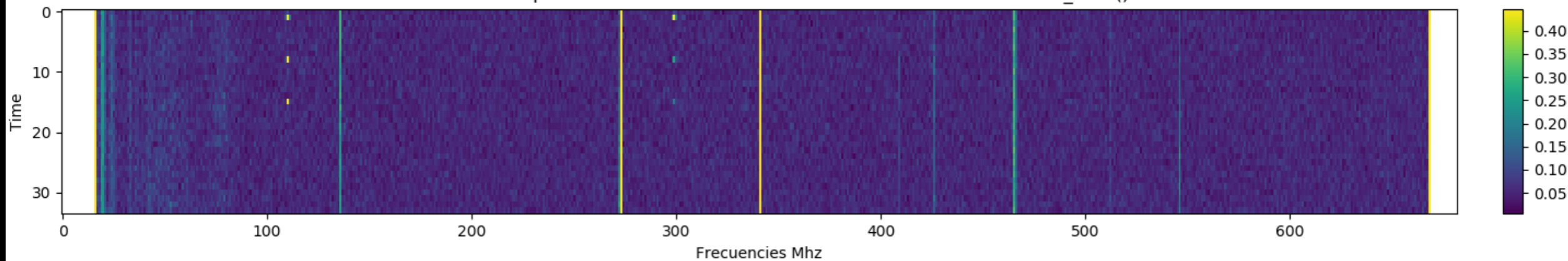

Zoom Selection : Between 1451.4465 Mhz and 1492.0959 Mhz

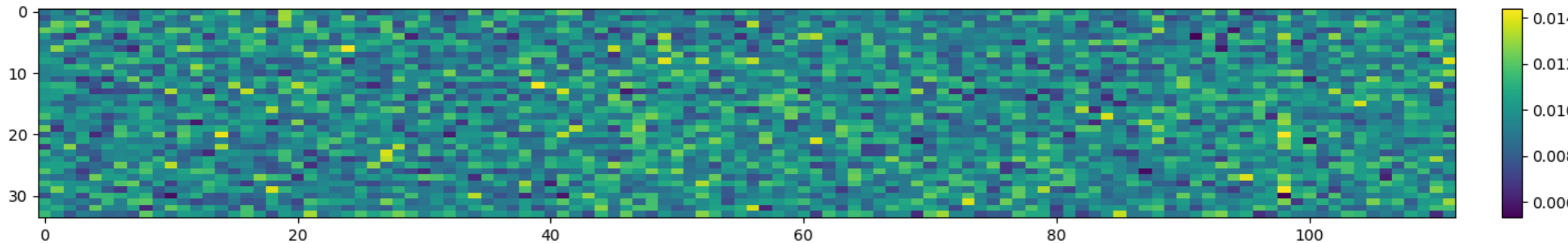

Zoom Selection : Between 1451.4465 Mhz and 1491.3635 Mhz

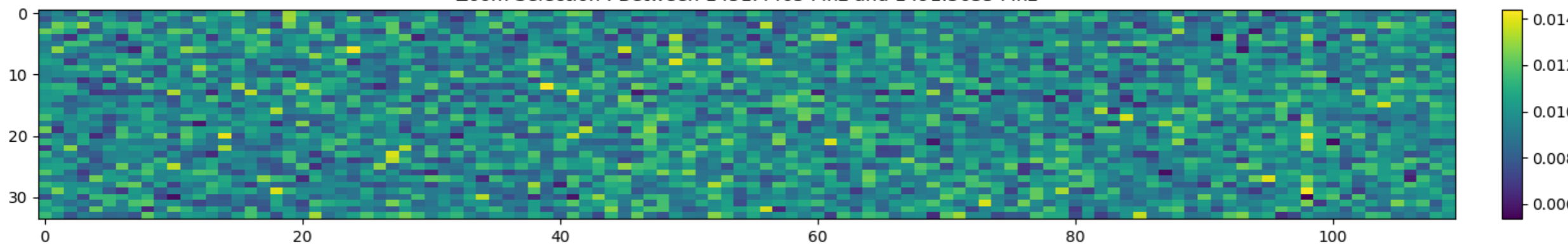

Average in time of counts-- : restricted zone time-frecuencie

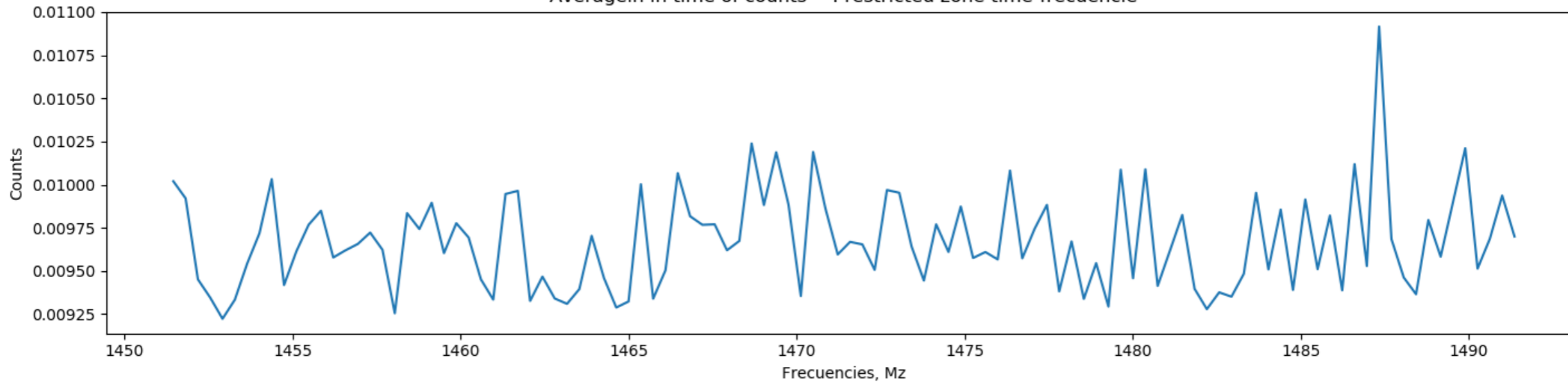

Signal sumed over : time interval 3367h - 3401h in f range 1451Mhz - 1491Mhz

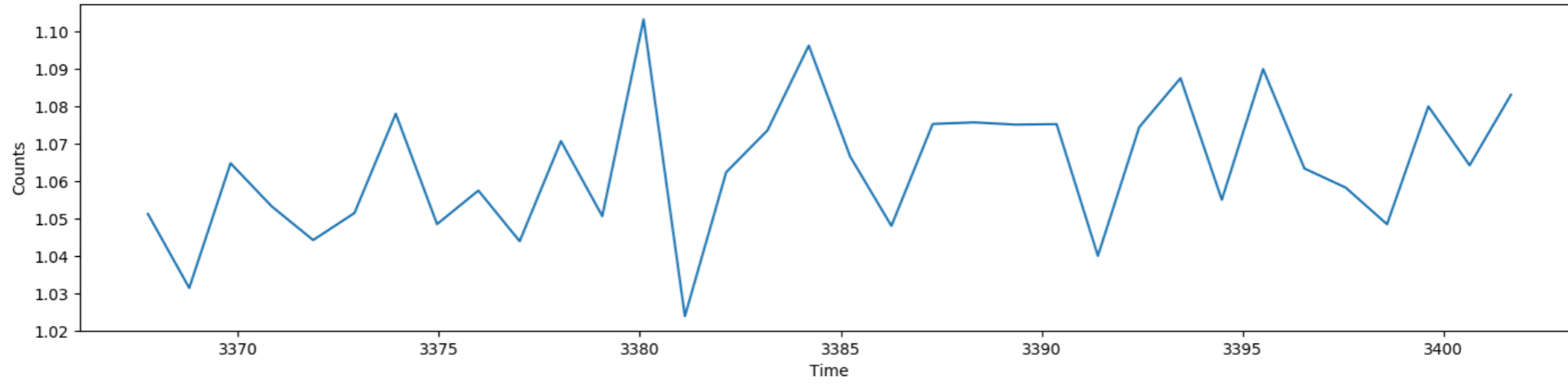

Averagein in time of counts-- : restricted zone time-frecuencie

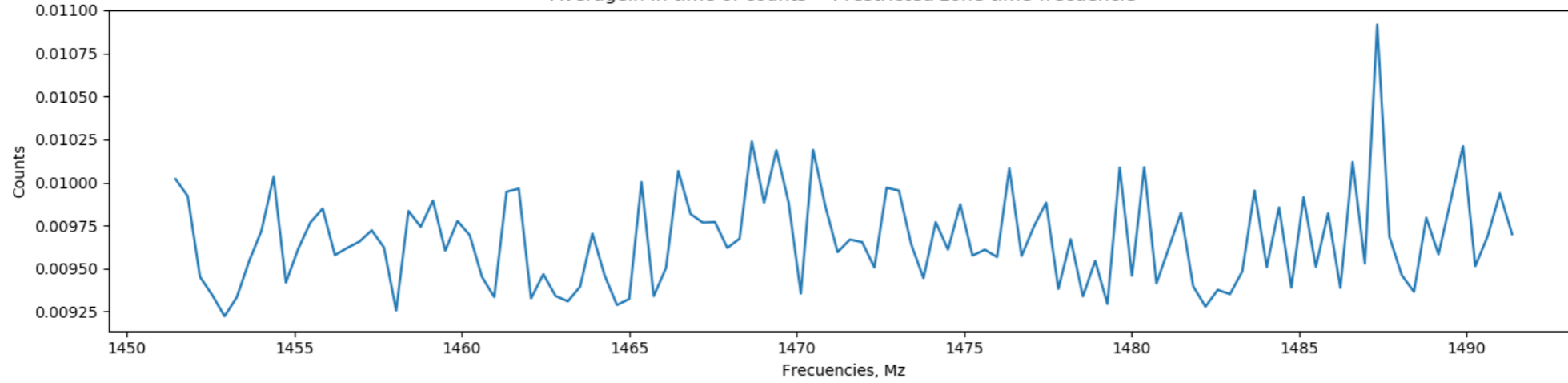

Signal sumed over : time interval 3367h - 3401h in f range 1308Mhz - 1343Mhz



Averagein in time of counts-- : restricted zone time-frecuencie

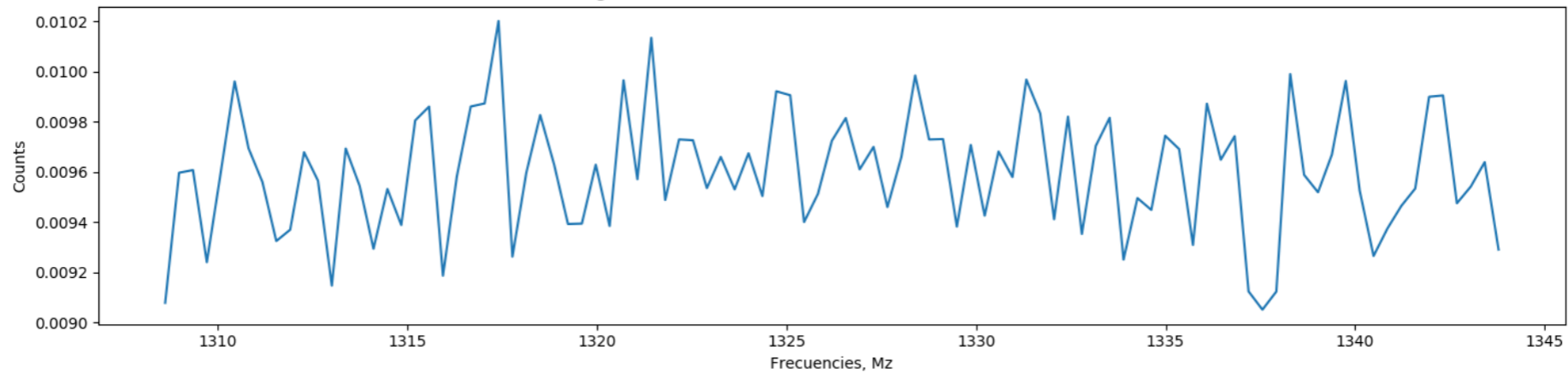

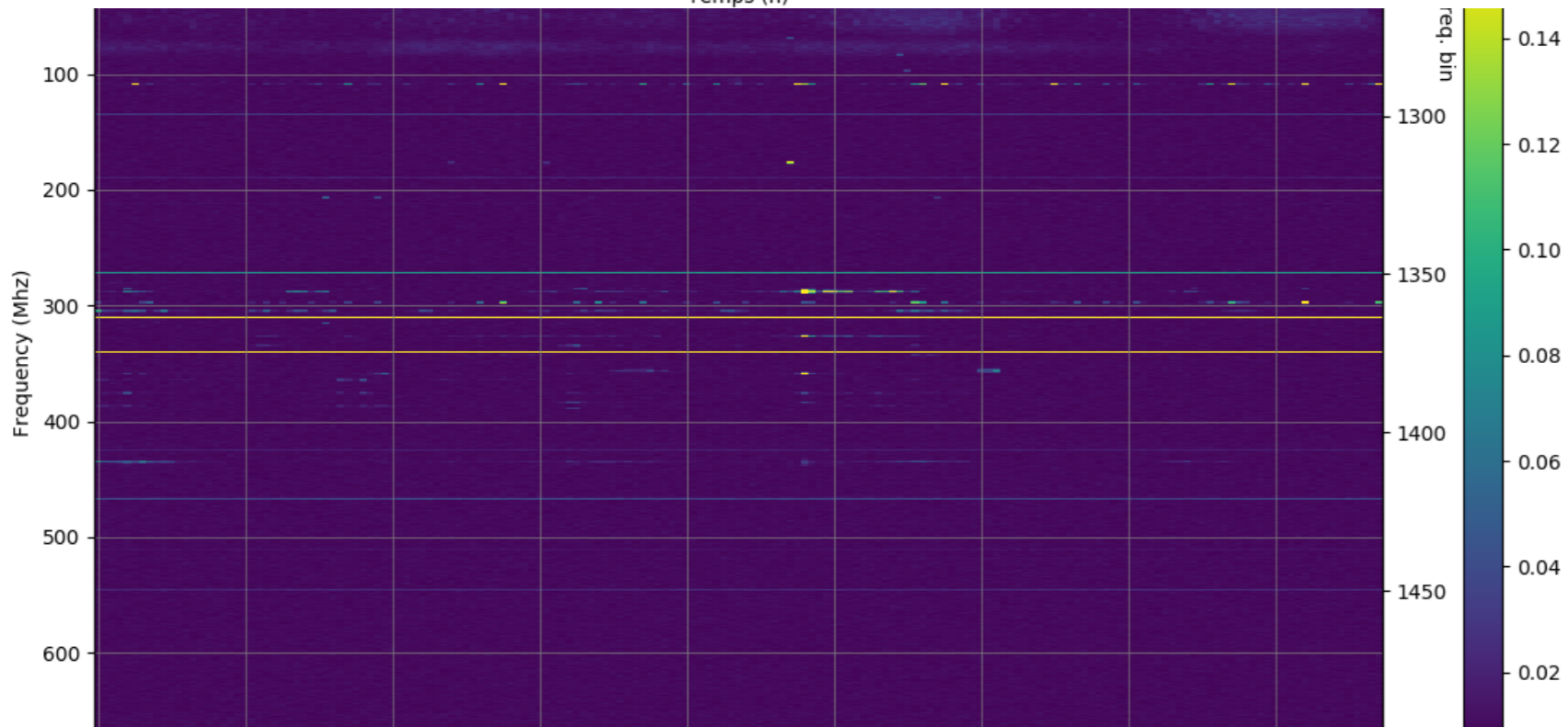
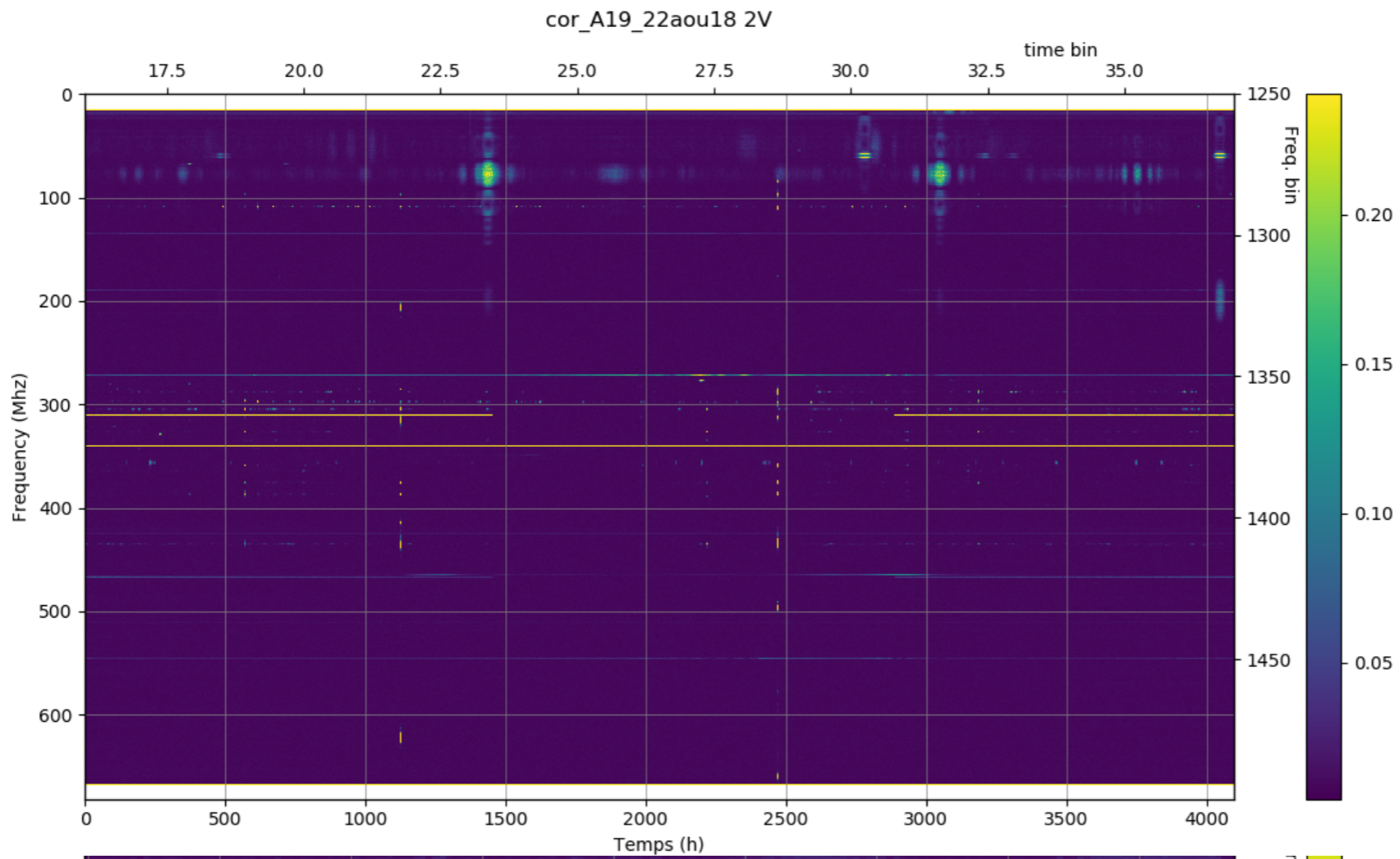

Input system

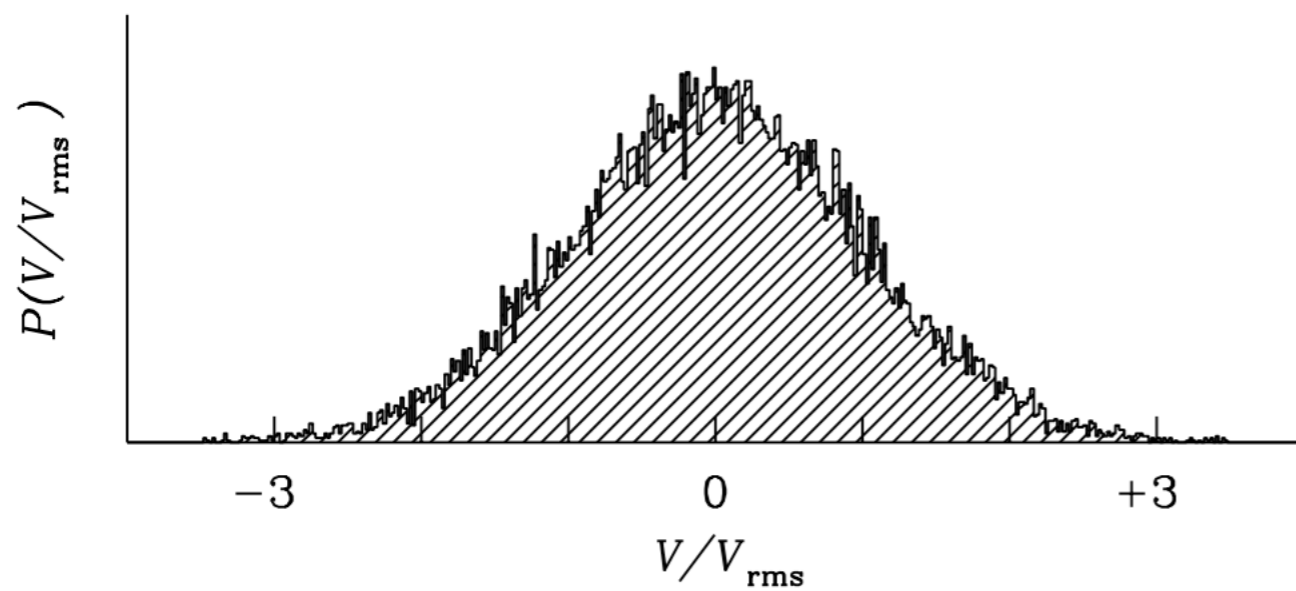
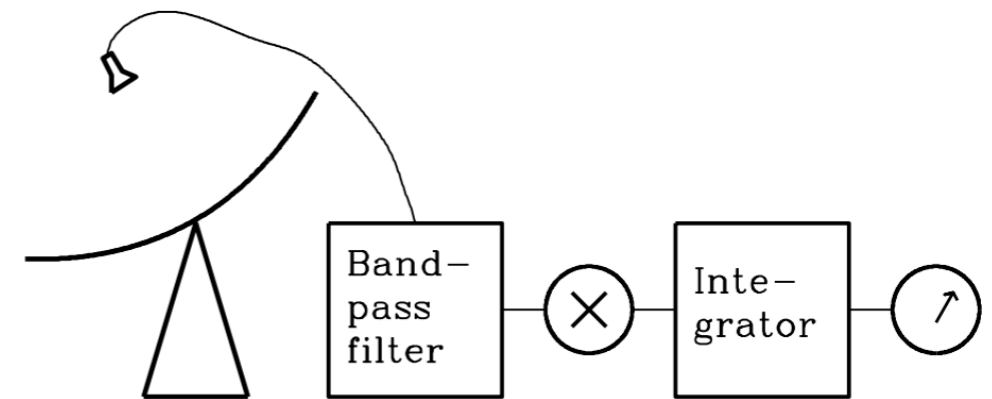
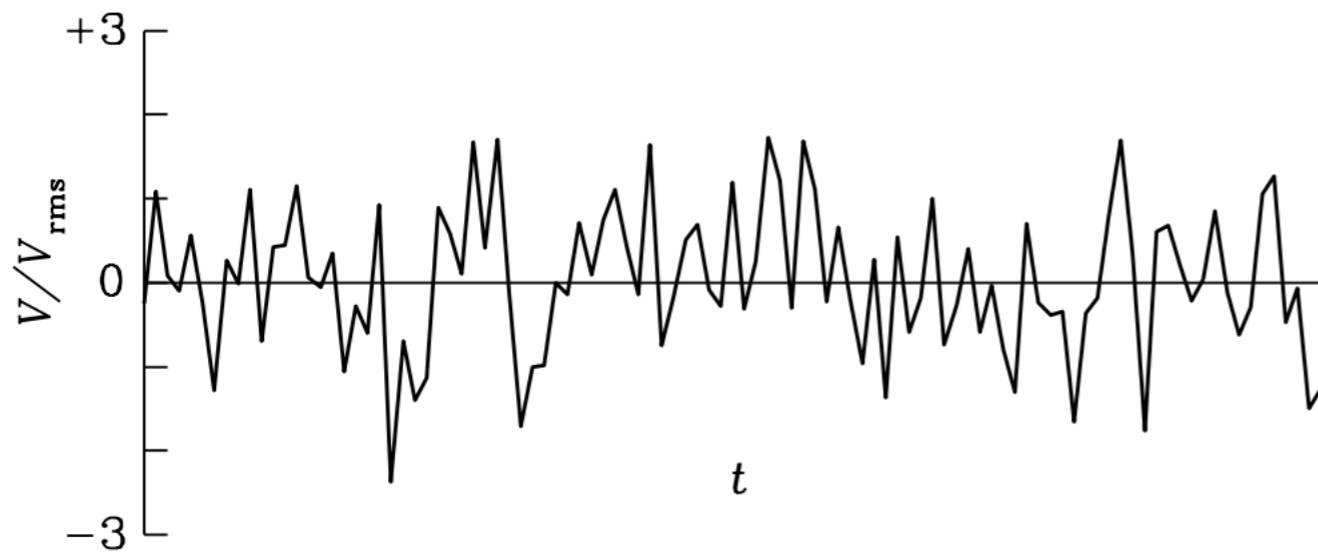

Output System

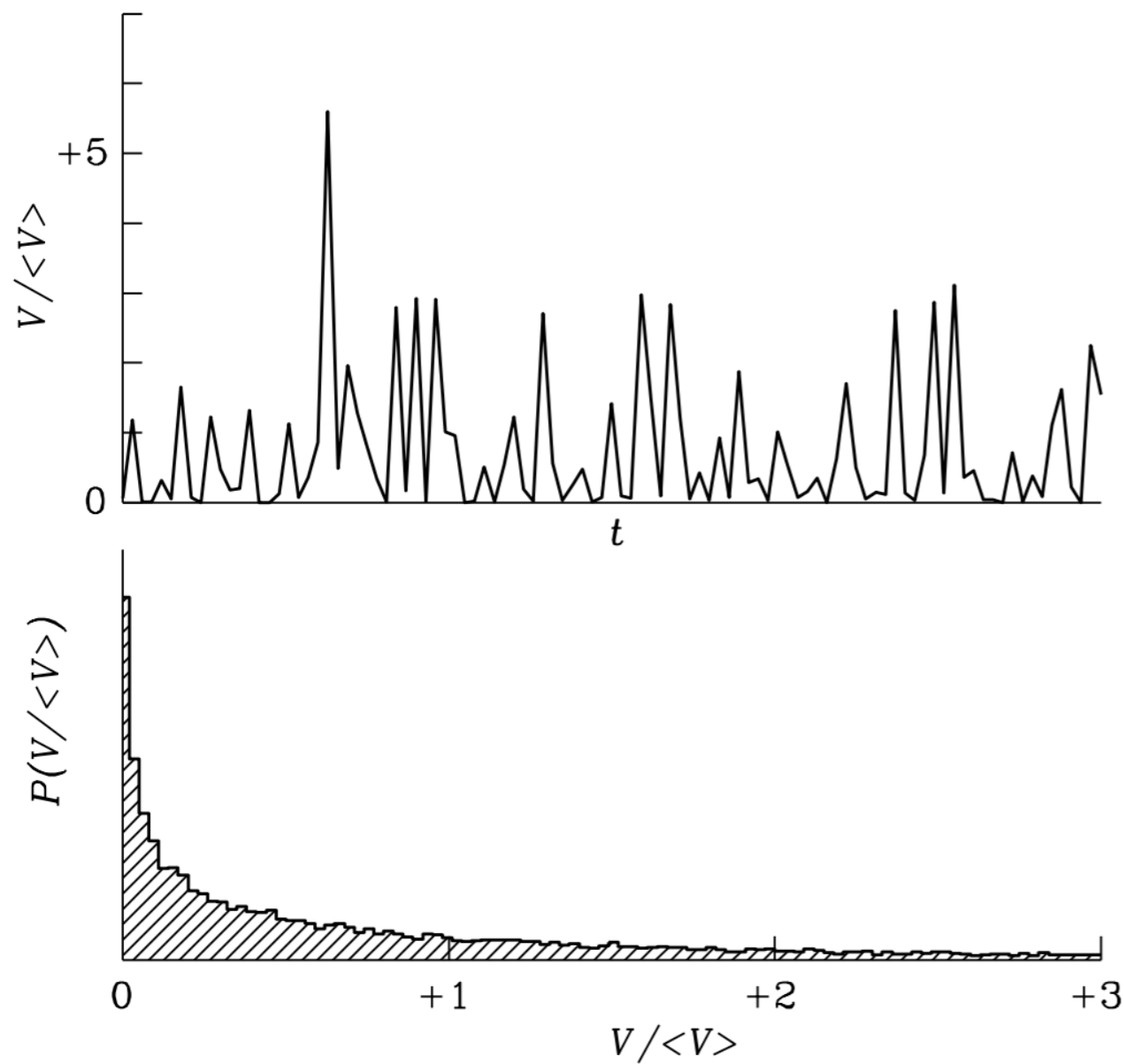

$$\sigma_T = \frac{2^{1/2} T_{\text{sys}}}{N^{1/2}} \cdot$$

Statistics 6 bin: 2019-05-23T11:34:5 Time (UT)19.479-20.579

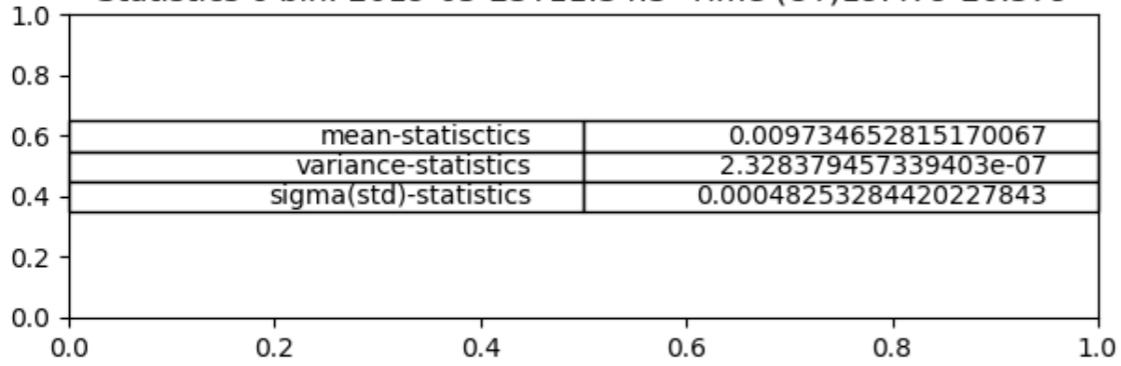

Resum of the info currently: file ---- 2019-05-23T11:34:5

time-Values	time-Bins	frecuencie-Values	frecuencie-Bins
19.478888888888888	380.7846786895761	1305.69458007812	152.5019229482485
20.584166666666666	596.537937810573	1307.52563476562	158.495238246202

Distribution : 1305.695Mhz-1307.159Mhz

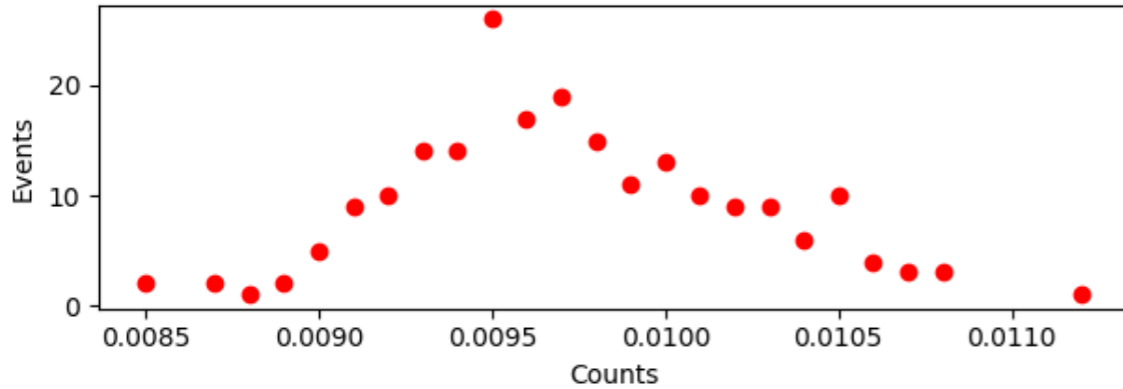

Statistic info: file ---- 2019-05-23T11:34:5

1.003059717792051	Mean-statistics
6.779411779185949	Variance-statistics
0.00260373035838697	Std-statistics

Statistics 3bits - 2019-05-23T11:34:5 Time (UT)19.753-20.582

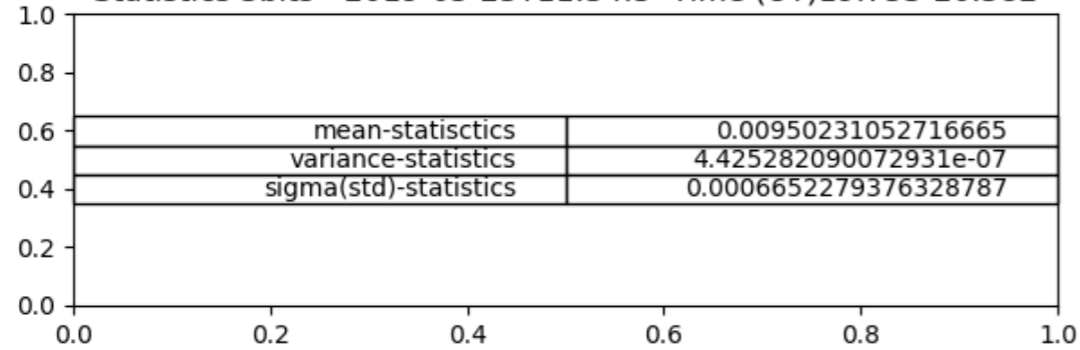

Statistics 12 bins : 2019-05-23T11:34:5 Time (UT)19.757-20.578

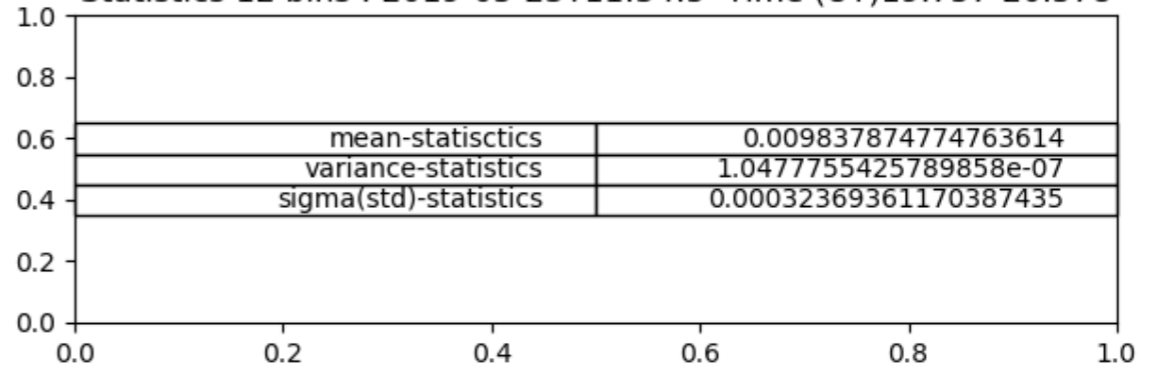

Distribution: 1305.695Mhz-1307.159Mhz

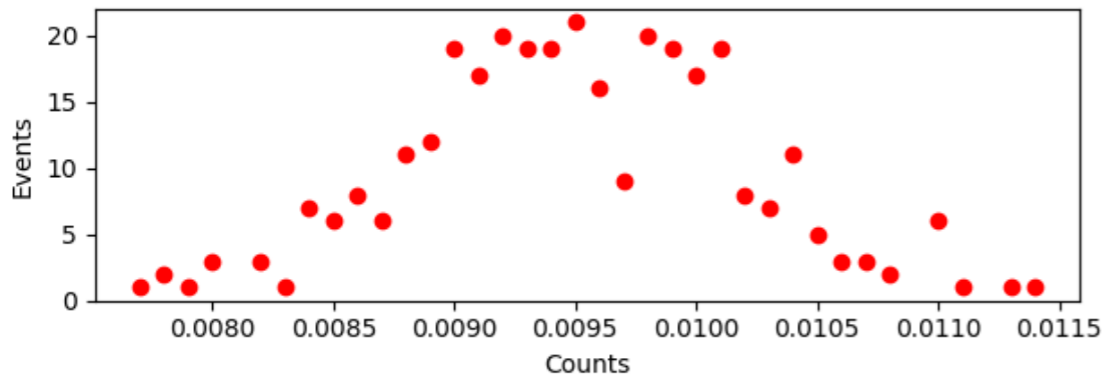

Distribution: 1305.695Mhz-1307.159Mhz

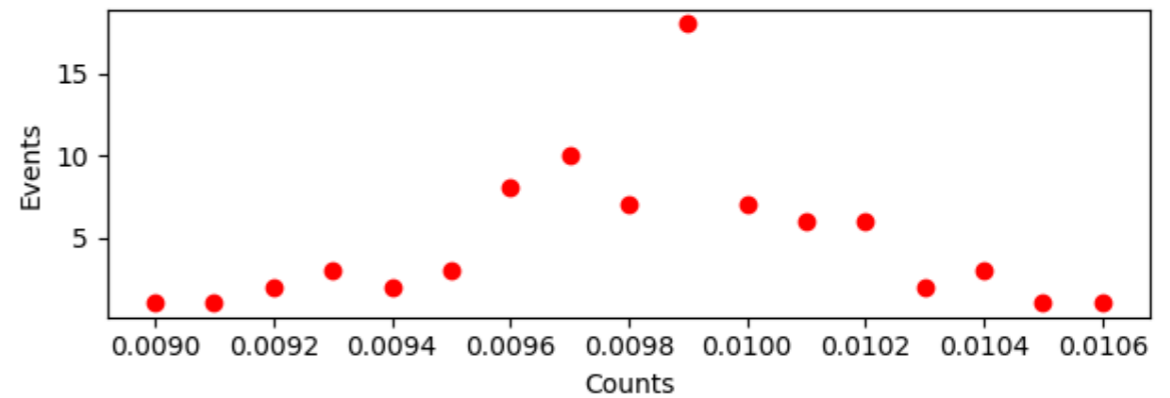

Quantity to study:

